

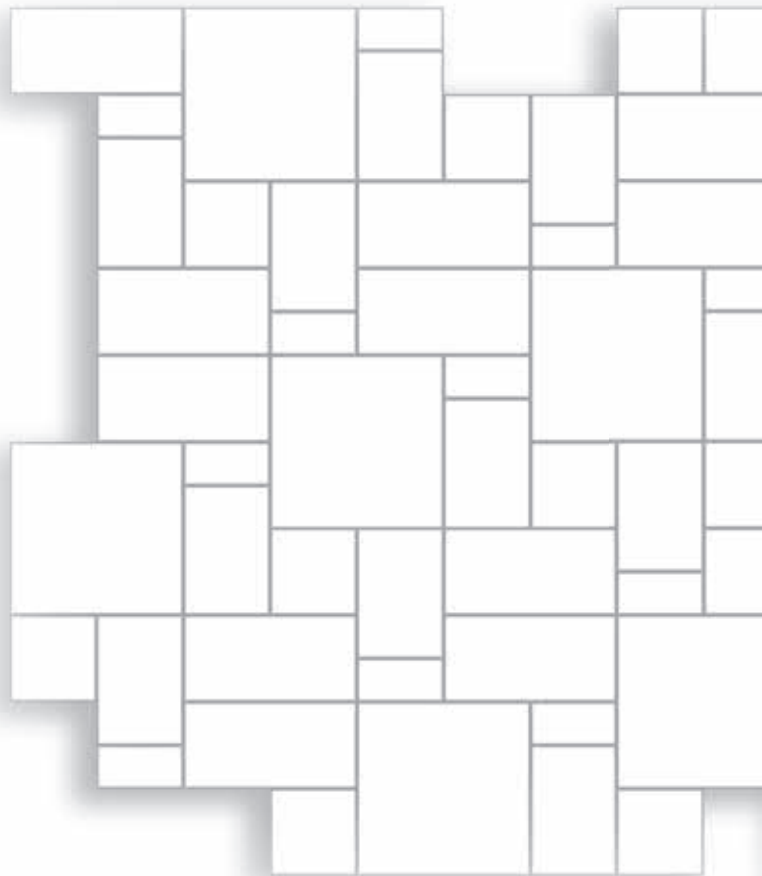

2014 TECHNICAL GUIDE



Navascape

Navascape is a leading manufacturer of concrete paving stones, architectural tiles, retaining walls and specialty products. With hundreds of shapes, sizes, colors and textures to choose from, the design possibilities are endless. Whatever your style, when you think hardscapes, think Navascape.

▪ Paving

Old World Cobble	3
Forest Hill Classic/Cobble	4
Rosemount	6
Kensington	7
Old Mill Cobble	8
European Cobble	9
Cobble Circle	9
English Cobble	10
Rosedale	12
Terramo	13
Stratford	14
Niagara	16
Turfstone	18
Roman Border	19
NaturalCast Traveno	20
NaturalCast Valentia	21
StoneTile Abruzzo	22
StoneTile Tuscanni	23
StoneTile Piazza	24
Smart Cast & Brick Impression	25
Smart Cast Clean & Reflect	26
Paving Specifications	27

▪ Walls

Antique RB Wall	28
Antique Kassel Wall	29
Antique Hampton Wall	30
Antique Tudor Wall	30
RB Wall	31
Wallstone & Wedgestone Wall	32
GRANDE Wall	34
Wall Specifications	35
Wall Design & Assembly	36
Corners, Steps & Columns	38

▪ Installation & Maintenance

Planning & Design	40
Paving Installation Guidelines	41
Typical Paving Cross-sections	44
Wall Installation Guidelines	45
Typical Wall Cross-section	46
Calculation Charts	47

Every effort has been made to ensure information in this guide is as accurate as possible at time of printing. Patterns have been designed to make efficient use of all stones within the bundle. However, mixed bundle configurations may not exactly meet pattern requirements. Some extra stones may be left over. Cutting may be required.

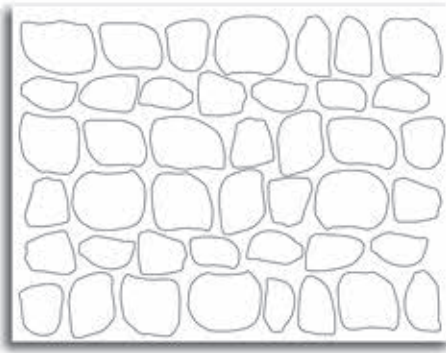

Old World Cobble has nine different sizes and shapes to create a truly random appearance.

Visit us online at www.navascape.ca for additional laying patterns.

- PR — pedestrian residential
 PC — pedestrian commercial
- VR — vehicular residential
 P — permeable

pattern: Random Runnerbond
100% old world cobble

<p>size: Nine sizes & shapes at 70 mm (2.76 in) thick</p> <p>ft²: 62.0* /bdl (*Qty may vary)</p> <p>pcs: 220* /bdl (*Qty may vary)</p> <p>lin ft: n/a</p> <p>sec/bdl: 1</p> <p>pcs/ft²: varies</p> <p>wt/pc: varies</p> <p>wt (lbs): 1600* /bdl (*Bundle weight may vary)</p>	
--	--

Old World Cobble

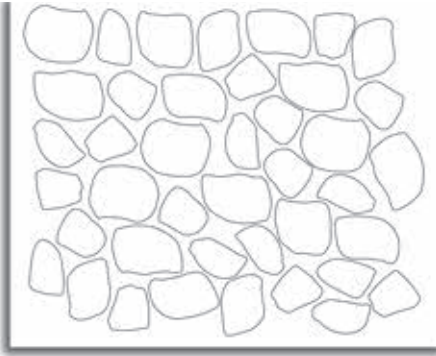

pattern: Random Cobble
100% old world cobble

Tips

Tightly fitted pavers are recommended for high pedestrian traffic areas and small spaces.

The larger the spaces between pavers, the more permeable the paved surface is, easily allowing rain to penetrate into the ground.

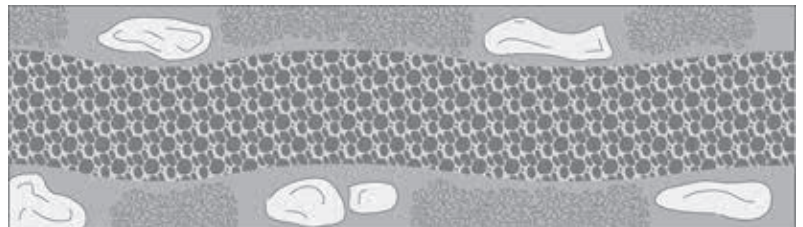

Stones may be packaged upside down. Ensure pavers are installed right side up.



Old World Cobble is ideal for creating organic pathways that connect one space to another. Its random cobble shape allows you to create irregular, free-formed walkways that blend beautifully with the surrounding natural environment.

Forest Hill Cobble has a textured surface and five stone sizes for random patterns.

Visit us online at www.navascape.ca for additional laying patterns.

-  pedestrian residential
-  pedestrian commercial
-  vehicular residential

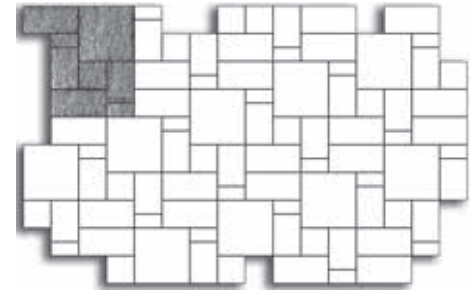

pattern 1: 5 Stone Random

- 31% large square
- 31% large rectangle
- 22% rectangle
- 8% square
- 8% small rectangle

Large Square



size:	359 x 359 x 70 mm	14.13 x 14.13 x 2.76 in
ft ² :	76.2 /bdl	25.4 /sec
pcs:	54 /bdl	18 /sec
lin ft:	64.1 /bdl	21.4 /sec
sec/bdl:	3	
pcs/ft ² :	0.71	
wt/pc:	45.3 lbs	20.6 kg
wt (lbs):	2446 /bdl	815 /sec

Large Rectangle



size:	359 x 179 x 70 mm	14.13 x 7.05 x 2.76 in
ft ² :	85.1 /bdl	28.4 /sec
pcs:	120 /bdl	40 /sec
lin ft:	71.7 /bdl	23.9 /sec
sec/bdl:	3	
pcs/ft ² :	1.41	
wt/pc:	21.8 lbs	9.9 kg
wt (lbs):	2621 /bdl	874 /sec

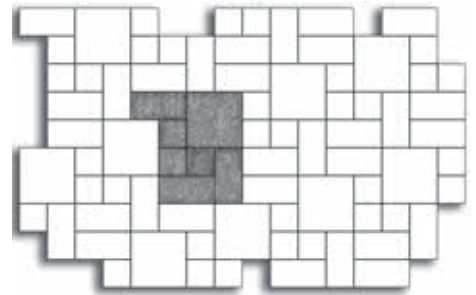

pattern 2: 3 Stone Random 1

- 31% large square
- 46% large rectangle
- 23% square

Rectangle



size:	269 x 179 x 70 mm	10.59 x 7.05 x 2.76 in
ft ² :	85.3 /bdl	21.3 /sec
pcs:	160 /bdl	40 /sec
lin ft:	95.5 /bdl	23.9 /sec
sec/bdl:	4	
pcs/ft ² :	1.88	
wt/pc:	16.7 lbs	7.6 kg
wt (lbs):	2670 /bdl	667 /sec

Square



size:	179 x 179 x 70 mm	7.05 x 7.05 x 2.76 in
ft ² :	85.6 /bdl	14.3 /sec
pcs:	240 /bdl	40 /sec
lin ft:	143.3 /bdl	23.9 /sec
sec/bdl:	6	
pcs/ft ² :	2.80	
wt/pc:	10.9 lbs	4.9 kg
wt (lbs):	2616 /bdl	436 /sec

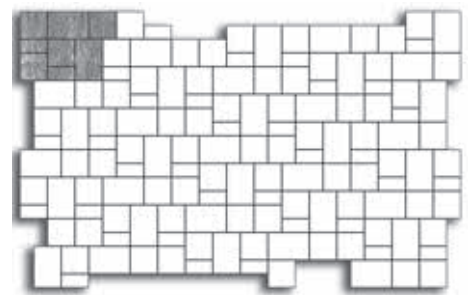

pattern 3: 3 Stone Random 2

- 37% rectangle
- 50% square
- 13% small rectangle

Small Rectangle



size:	179 x 89 x 70 mm	7.05 x 3.5 x 2.76 in
ft ² :	86.5 /bdl	14.4 /sec
pcs:	480 /bdl	80 /sec
lin ft:	144.9 /bdl	24.2 /sec
sec/bdl:	6	
pcs/ft ² :	5.55	
wt/pc:	5.4 lbs	2.5 kg
wt (lbs):	2603 /bdl	434 /sec

*Products available while supplies last.

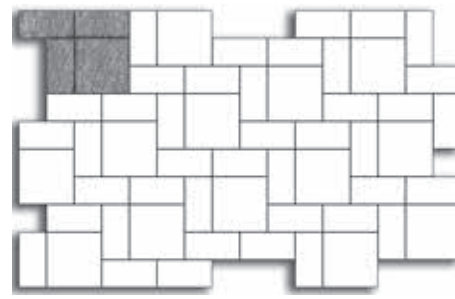
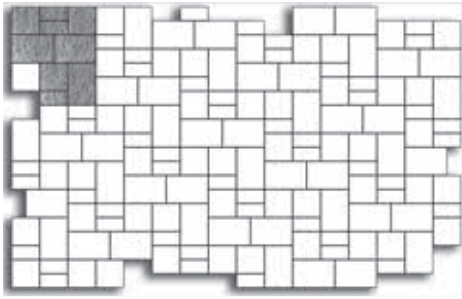

pattern 4: 3 Stone Random 3

50% rectangle
33% square
17% small rectangle

pattern 7: Modified Herringbone 1

40% large square
60% large rectangle

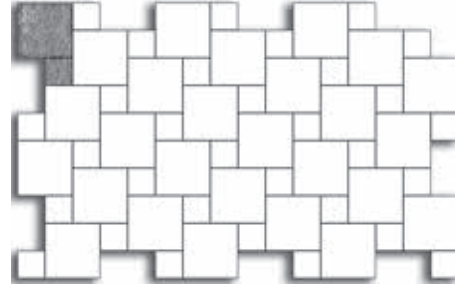
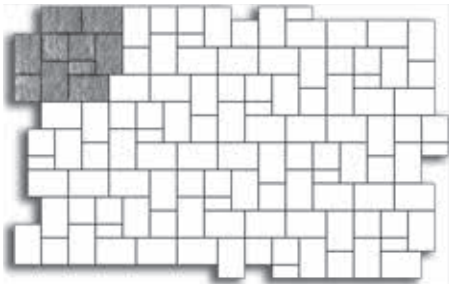

pattern 5: 3 Stone Random 4

72% rectangle
24% square
4% small rectangle

pattern 8: Modified Herringbone 3

80% large square
20% square

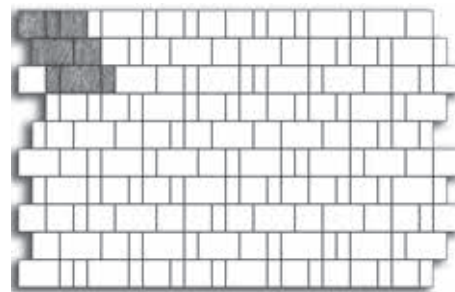
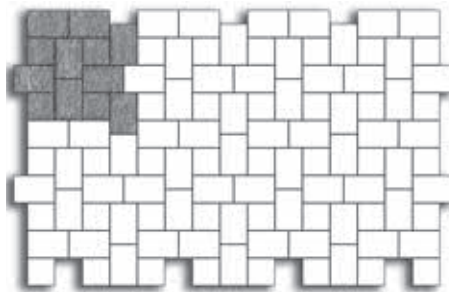

pattern 6: Modified Herringbone

75% rectangle
25% square

pattern 9: Modified Runnerbond 4

40% rectangle
40% square
20% small rectangle

Tips

Stones may be packaged upside down. Ensure pavers are installed right side up.

Begin laying pavers at a corner, using a string or chalk line to keep lines straight.

Forest Hill Cobble does not have spacer bars. Leave a 1.5-3 mm (1/16-1/8 in) space around the paver to act as a joint.

To ensure proper color blending, take pieces from several bundles at once. Remove paving stones in stacks rather than in layers.

Install the main body of the installation, then go back and cut pieces to fill in the edges. Cut pieces less than one third their original size are likely to break. Cut two larger pieces instead.

*Products available while supplies last.

Rosemount New

Visit us online at www.navascape.ca for additional laying patterns.

- PR — pedestrian residential
 PC — pedestrian commercial
- VR — vehicular residential

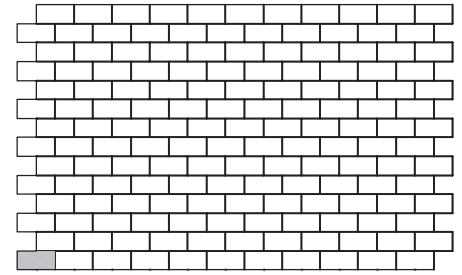

pattern 1: Runnerbound

size:	100 x 200 x 60 mm	3 15/16 x 7 7/8 x 2 3/8 in
ft ² :	104.67 /bdl	11.63 /sec
pcs:	486 /bdl	54 /sec
lin ft:	318.87 /bdl	35.43 /sec
sec/bdl:	9	
pcs/ft ² :	4.64	
wt/pc:	5.48 lbs	
wt (lbs):	2729 /bdl	

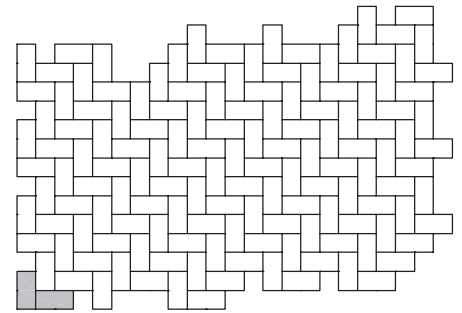

pattern 2: Herringbone

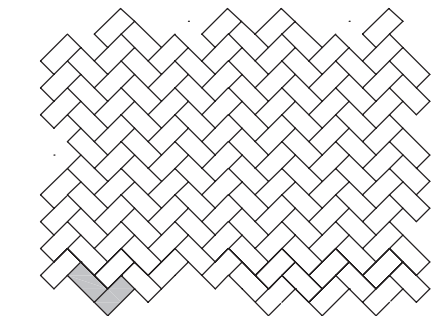

pattern 3: Herringbone Weave

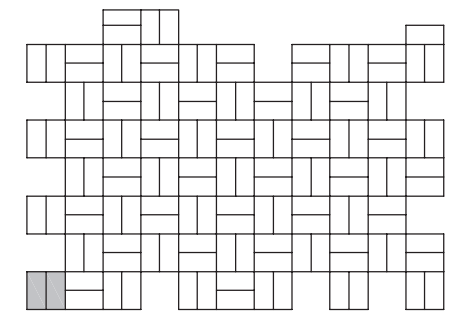

pattern 4: Parquet



Rosemount

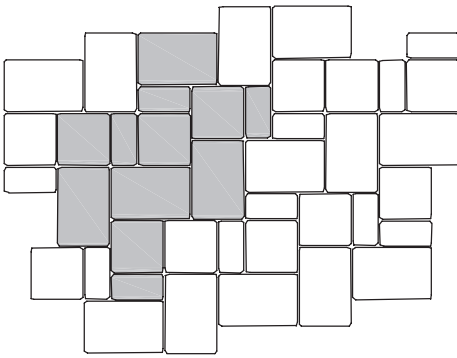

pattern 1: 3 Stone Random

Kensington
 Visit us online at www.navascape.ca
 for additional laying patterns.

PR — pedestrian residential PC — pedestrian commercial
 VR — vehicular residential

size:	419 x 279 x 80 mm	16.50 x 10.98 x 3.15 in
pcs/ft ² :	0.78	
wt/pc:	47.10 lbs	
size:	279 x 279 x 80 mm	10.98 x 10.98 x 3.15 in
pcs/ft ² :	1.17	
wt/pc:	31.60 lbs	
size:	279 x 139 x 80 mm	10.98 x 5.47 x 3.15 in
pcs/ft ² :	2.32	
wt/pc:	15.60 lbs	
area/cube:	71.90 ft ²	
weight/cube:	2640 lbs	

Mixed bundle

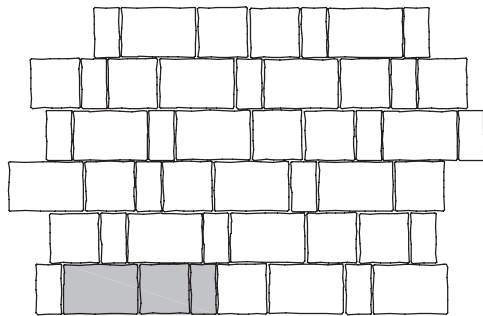
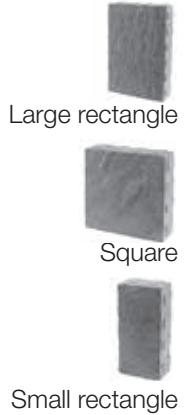

pattern 2: 3 Stone Runnerbond

size:	279 x 209 x 80 mm	10.98 x 8.23 x 3.15 in
ft ² :	72.10 /bdl	18.0/sec
pcs:	112 /bdl	28/sec
lin ft:	77.90 /bdl	19.50/sec
sec/bdl:	4	
pcs/ft ² :	1.55	
wt/pc:	22.70 lbs	
wt (lbs):	2540 lbs	



pattern 3: Herringbone

100% rectangle

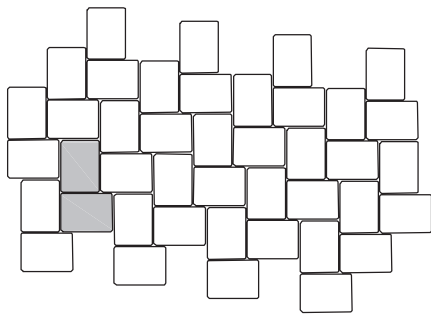

pattern 4: Herringbone Weave

100% rectangle

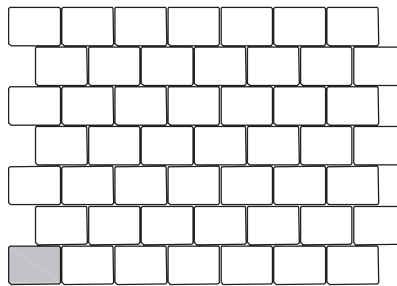

pattern 5: Runnerbond

100% rectangle

Old Mill Cobble can be used to create random patterns.
 Use Cobble Circle to incorporate circles, arcs and fans.
 Visit us online at www.navascape.ca
 for additional laying patterns.

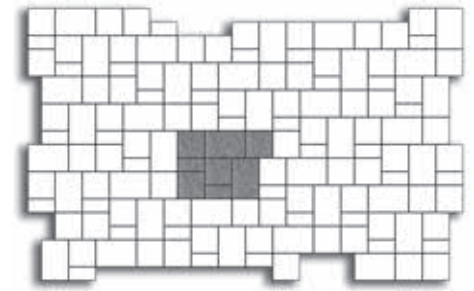
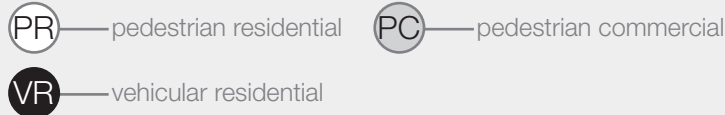

pattern 1: 3 Stone Random 1

37% old mill large rectangle
 50% old mill square
 13% old mill rectangle

Large Rectangle



size:	312 x 208 x 70 mm	12.28 x 8.19 x 2.76 in
ft ² :	91.6 /bdl	22.9 /sec
pcs:	128 /bdl	32 /sec
lin ft:	88.6 /bdl	22.2 /sec
sec/bdl:	4	
pcs/ft ² :	1.40	
wt/pc:	22.9 lbs	10.4 kg
wt (lbs):	2927 /bdl	732 /sec

Square



size:	208 x 208 x 70 mm	8.19 x 8.19 x 2.76 in
ft ² :	92.0 /bdl	15.3 /sec
pcs:	192 /bdl	32 /sec
lin ft:	132.9 /bdl	22.2 /sec
sec/bdl:	6	
pcs/ft ² :	2.09	
wt/pc:	15.3 lbs	6.9 kg
wt (lbs):	2937 /bdl	490 /sec

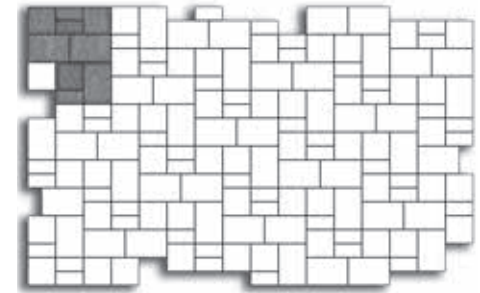

pattern 2: 3 Stone Random 2

50% old mill large rectangle
 33% old mill square
 17% old mill rectangle

Rectangle



size:	208 x 104 x 70 mm	8.19 x 4.09 x 2.76 in
ft ² :	93.3 /bdl	15.6 /sec
pcs:	384 /bdl	64 /sec
lin ft:	134.8 /bdl	22.5 /sec
sec/bdl:	6	
pcs/ft ² :	4.11	
wt/pc:	7.7 lbs	3.5 kg
wt (lbs):	2942 /bdl	490 /sec

Large Square



size:	312 x 312 x 70 mm	12.28 x 12.28 x 2.76 in
ft ² :	100.6 /bdl	12.6 /sec
pcs:	96 /bdl	12 /sec
lin ft:	98.3 /bdl	12.3 /sec
sec/bdl:	8	
pcs/ft ² :	0.95	
wt/pc:	34.6 lbs	15.7 kg
wt (lbs):	3376 /bdl	422 /sec

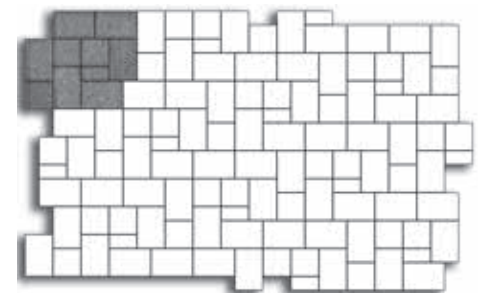

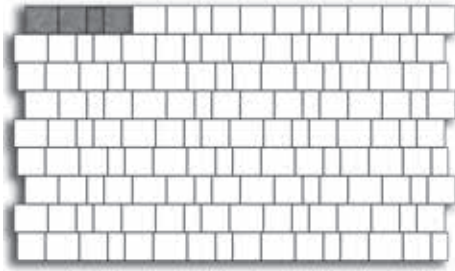

pattern 3: 3 Stone Random 3

72% old mill large rectangle
 24% old mill square
 4% old mill rectangle



European Cobble has three sizes for linear designs. Use Cobble Circle to incorporate circles, arcs and fans.
 Visit us online at www.navascape.ca for additional laying patterns.

-  pedestrian residential
-  pedestrian commercial
-  vehicular residential

pattern 1: 3 Stone Runnerbond

31% european large rectangle
 53% european square
 16% european rectangle

size:	208 x 173 x 70 mm	8.19 x 6.81 x 2.76 in
ft ² :	89.5 /bdl	12.8 /sec
pcs:	224 /bdl	32 /sec
lin ft:	129.3 /bdl	18.5 /sec
sec/bdl:	7	
pcs/ft ² :	2.50	
wt/pc:	12.6 lbs	5.7 kg
wt (lbs):	2814 /bdl	402 /sec

Large Rectangle

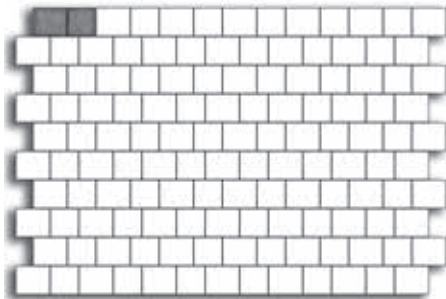

size:	173 x 173 x 70 mm	6.81 x 6.81 x 2.76 in
ft ² :	93.4 /bdl	13.3 /sec
pcs:	280 /bdl	40 /sec
lin ft:	161.7 /bdl	23.1 /sec
sec/bdl:	7	
pcs/ft ² :	3.00	
wt/pc:	10.6 lbs	4.8 kg
wt (lbs):	2977 /bdl	425 /sec

Square



pattern 2: 2 Stone Runnerbond

55% european large rectangle
 45% european square

size:	173 x 104 x 70 mm	6.81 x 4.09 x 2.76 in
ft ² :	90.8 /bdl	13.0 /sec
pcs:	448 /bdl	64 /sec
lin ft:	157.3 /bdl	22.5 /sec
sec/bdl:	7	
pcs/ft ² :	4.93	
wt/pc:	6.3 lbs	2.9 kg
wt (lbs):	2836 /bdl	405 /sec

Rectangle

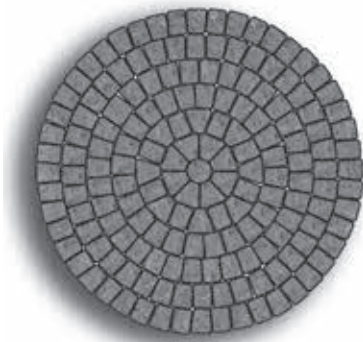

pattern 3: Cobble Circle

100% cobble circle

size:	Various sizes at 70 mm (2.76 in) thick	
ft ² :	47.0 /bdl	
pcs/bdl:	60 - 3/4 stones	110 - 15° wedges
	20 - 45° wedges	5 - center stones
sec/bdl:	1	
wt/pc:	varies	
wt (lbs):	1556 /bdl	

Cobble Circle



notes: Cobble Circle creates one circle with a diameter of 2286 mm (7' 6"). Complete row-by-row instructions are available online.

English Cobble has four stone sizes for creating random patterns.

Visit us online at www.navascape.ca for additional laying patterns.

- PR — pedestrian residential
- PC — pedestrian commercial
- VR — vehicular residential

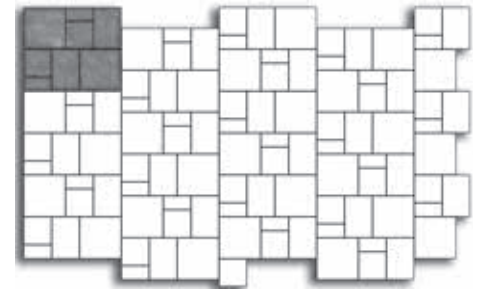

pattern 1: 4 Stone Random 1

43% large square
57% mixed bundle

Large Square



size:	223 x 223 x 60 mm	8.78 x 8.78 x 2.36 in
ft²:	88.0 /bdl	17.6 /sec
pcs:	160 /bdl	32 /sec
lin ft:	118.6 /bdl	23.7 /sec
sec/bdl:	5	
pcs/ft²:	1.82	
wt/pc:	14.7 lbs	6.7 kg
wt (lbs):	2352 /bdl	470 /sec

Rectangle



size:	223 x 148 x 60 mm	8.78 x 5.83 x 2.36 in
ft²:	88.2 /bdl	17.6 /sec
pcs:	240 /bdl	48 /sec
lin ft:	118.9 /bdl	23.8 /sec
sec/bdl:	5	
pcs/ft²:	2.72	
wt/pc:	10.2 lbs	4.6 kg
wt (lbs):	2453 /bdl	491 /sec

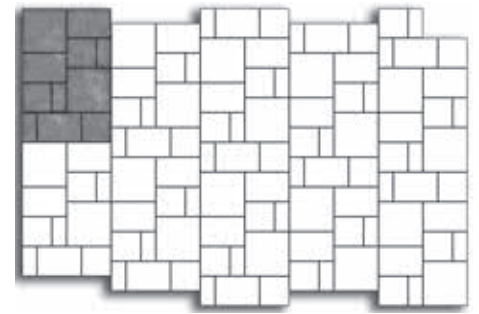

pattern 2: 4 Stone Random 2

33% large square
67% mixed bundle

Mixed Bundle



Rectangle



Square



Small Rectangle

size:	223 x 148 x 60 mm	8.78 x 5.83 x 2.36 in
pcs/ft²:	2.72	
wt/pc:	10.2 lbs	4.6 kg
size:	148 x 148 x 60 mm	5.83 x 5.83 x 2.36 in
pcs/ft²:	4.07	
wt/pc:	6.6 lbs	3.0 kg
size:	148 x 73 x 60 mm	5.83 x 2.87 x 2.36 in
pcs/ft²:	8.1	
wt/pc:	3.3 lbs	1.5 kg
ft²:	94.2 /bdl	
pcs:	128* rec + 128* square + 128* small rec /bdl	
	(*Qty may vary)	
lin ft:	n/a	
sec/bdl:	1	
wt (lbs):	2411 /bdl	

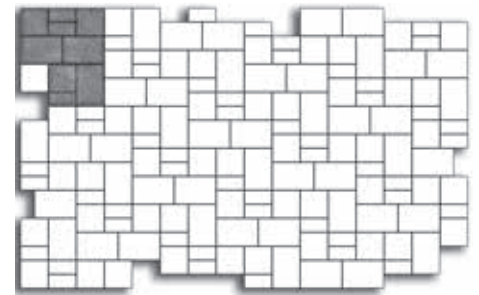

pattern 3: 3 Stone Random

100% mixed bundle

Mixed bundle configurations may not exactly meet pattern requirements. Stones may be left over. Cutting may be required.

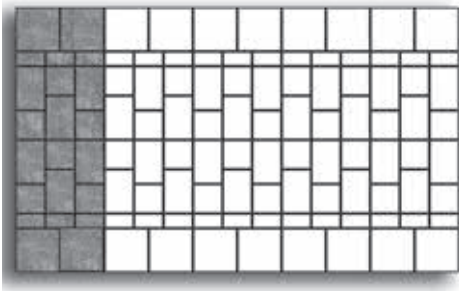
**pattern 4: English Sidewalk**

33% large square
67% mixed bundle

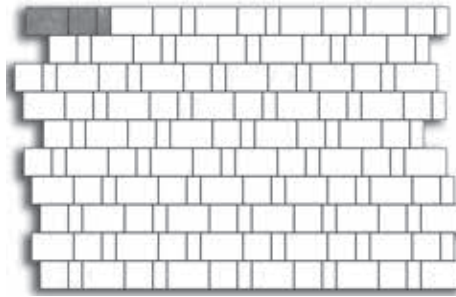
**pattern 7: Modified Runnerbond**

100% mixed bundle

**pattern 5: Herringbone Weave**

100% rectangle

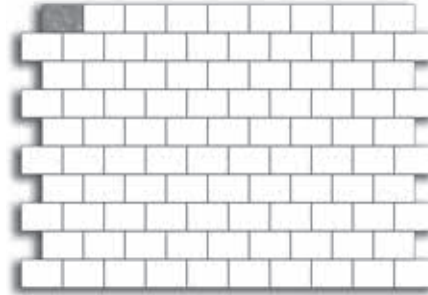
**pattern 8: Runnerbond**

100% rectangle

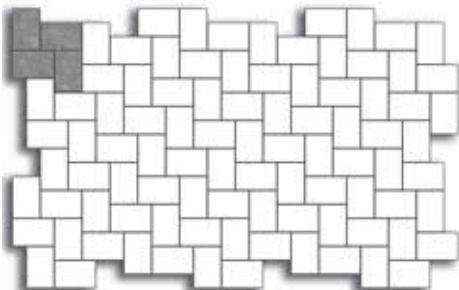
**pattern 6: Herringbone**

100% rectangle

notes: For superior results, mark off a true 90° angle before you begin laying the pavers.

Tips

Stones may be packaged upside down. Ensure pavers are installed right side up.

Begin laying pavers at a corner, using a string or chalk line to keep lines straight.

English Cobble does not have spacer bars. Leave a 1.5-3 mm (1/16-1/8 in) space around the paver to act as a joint.

To ensure proper color blending, take pieces from several bundles at once. Remove paving stones in stacks rather than in layers.

Install the main body of the installation, then go back and cut pieces to fill in the edges. Cut pieces less than one third their original size are likely to break. Cut two larger pieces instead.

Rosedale has a lightly textured surface, three sizes and two thicknesses for random patterns.

Visit us online at www.navascape.ca for additional laying patterns.

-  pedestrian residential
-  pedestrian commercial
-  vehicular residential
-  vehicular commercial

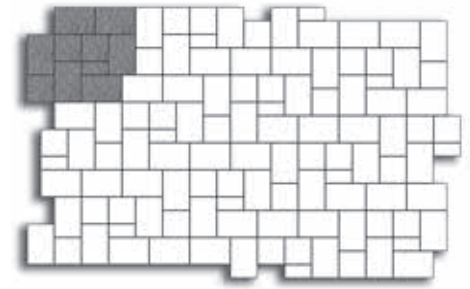

pattern 1: 3 Stone Random

72% rectangle
28% square bundle

notes: Bundle configuration may not exactly meet pattern requirements. Use extra small rectangles at edges to minimize cutting.

Rosedale 60



Rectangle

size:	223 x 148 x 60 mm	8.78 x 5.83 x 2.36 in
ft ² :	82.6 /bdl	16.5 /sec
pcs:	225 /bdl	45 /sec
lin ft:	111.5 /bdl	22.3 /sec
sec/bdl:	5	
pcs/ft ² :	2.72	
wt/pc:	10.1 lbs	4.6 kg
wt (lbs):	2264 /bdl	453 /sec

Square Bundle



Square



Small Rectangle

size:	148 x 148 x 60 mm	5.83 x 5.83 x 2.36 in
pcs/ft ² :	4.07	
wt/pc:	7.1 lbs	3.2 kg
size:	148 x 73 x 60 mm	5.83 x 2.87 x 2.36 in
pcs/ft ² :	8.10	
wt/pc:	3.5 lbs	1.6 kg
ft ² :	77.4 /bdl	11.1 /sec
pcs:	261* square + 108* small rec /bdl (*Qty may vary)	
lin ft:	n/a	
sec/bdl:	7	
wt (lbs):	2116 /bdl	302 /sec

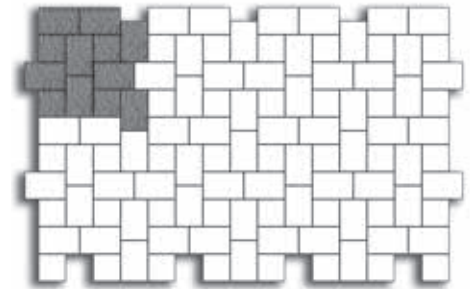

pattern 2: Modified Herringbone

75% rectangle
25% square bundle

notes: Use small rectangles at edges to minimize cutting or put two together to replace one square at various intervals throughout the pattern.

Rosedale 80



Rectangle



Square

size:	223 x 148 x 80 mm	8.78 x 5.83 x 3.15 in
pcs/ft ² :	2.72	
wt/pc:	13.2 lbs	6.0 kg
size:	148 x 148 x 80 mm	5.83 x 5.83 x 3.15 in
pcs/ft ² :	4.07	
wt/pc:	8.8 lbs	4.0 kg
ft ² :	82.7 /bdl	11.8 /sec
pcs:	135* rectangle + 135* square /bdl (*Qty may vary)	
lin ft:	n/a	
sec/bdl:	7	
wt (lbs):	2968 /bdl	424 /sec

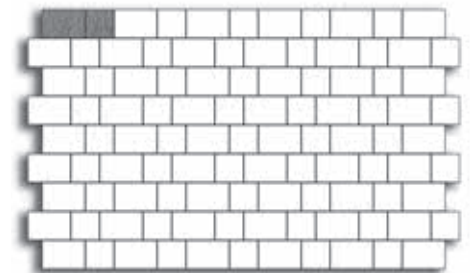

pattern 3: Modified Runnerbond

60% rectangle
40% square bundle

notes: Use small rectangles at edges to minimize cutting or intersperse periodically throughout the pattern.

Mixed bundle configurations may not exactly meet pattern requirements. Stones may be left over. Cutting may be required.

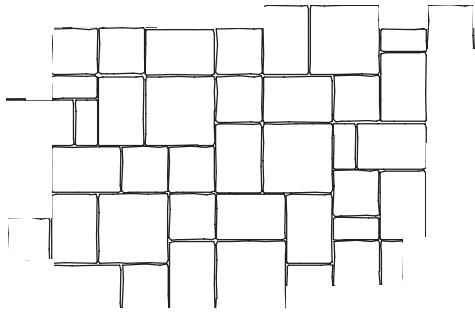

pattern 1: 4 Stone Random

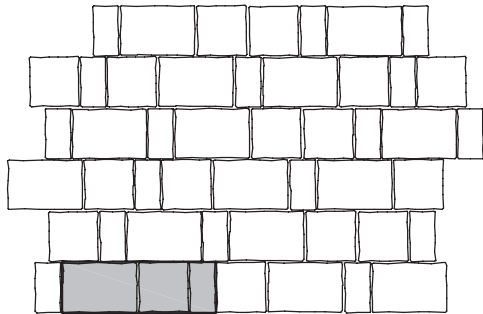

pattern 2: 4 Stone Runnerbond

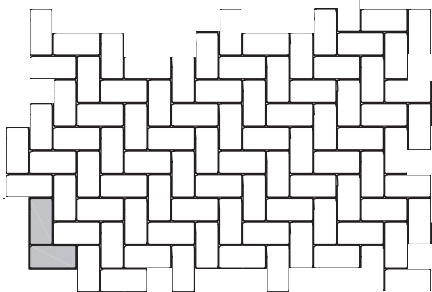

pattern 3: Herringbone

100% rectangle

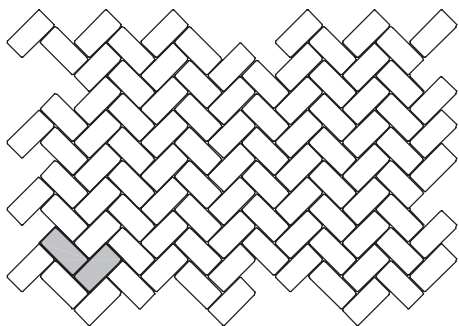

pattern 4: Herringbone Weave

100% rectangle

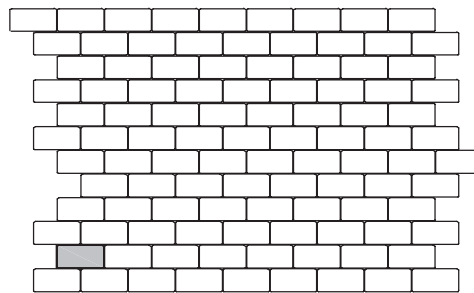

pattern 5: Runnerbond

100% rectangle

Terramo
Visit us online at www.navascape.ca
for additional laying patterns.

- PR — pedestrian residential
- PC — pedestrian commercial
- VR — vehicular residential

size:	373 x 373 x 80 mm	14.69 x 14.69 x 3.15 in
pcs/ft ²	0.66	
wt/pc:	58.0 lbs	
size:	373 x 248 x 80 mm	14.69 x 9.76 x 3.15 in
pcs/ft ²	0.98	
wt/pc:	39.20 lbs	
size:	248 x 248 x 80 mm	9.76 x 9.76 x 3.15 in
pcs/ft ²	1.47	
wt/pc:	214.90 lbs	
size:	248 x 123 x 80 mm	9.76 x 4.84 x 3.15 in
pcs/ft ²	2.94	
wt/pc:	11.80 lbs	
area/cube	81.30 ft ²	
weight/cube	3071 lbs	

size:	248 x 123 x 80 mm	9.76 x 4.84 x 3.15 in
ft ² :	71.50 /bdl	14.30 /sec
pcs:	210 /bdl	42/sec
lin ft:	86.80 /bdl	17.40/sec
sec/bdl:	5	
pcs/ft ² :	2.94	
wt/pc:	11.80 lbs	
wt (lbs):	2472 lbs	

Mixed bundle



Large square



Large rectangle



Square





Rectangle



Rectangle

Stratford has a rounded cobble appearance, four stone sizes for random patterns and a circle kit.

Visit us online at www.navascape.ca for additional laying patterns.

-  pedestrian residential
-  pedestrian commercial
-  vehicular residential

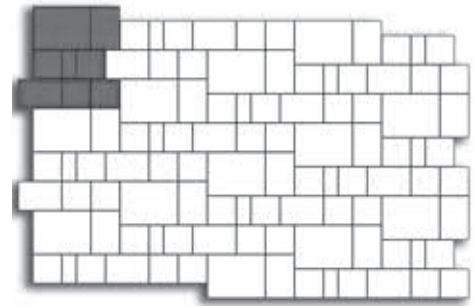

pattern 1: 4 Stone Random

- 28% double rectangle
- 29% rectangle
- 43% square bundle

notes: Bundle configuration may not exactly meet pattern requirements. Use extra Small Rectangles at edges to minimize cutting.

Double Rectangle



size:	238 x 178 x 60 mm	9.37 x 7.01 x 2.36 in
ft ² :	94.0 /bdl	18.8 /sec
pcs:	200 /bdl	40 /sec
lin ft:	118.8 /bdl	23.8 /sec
sec/bdl:	5	
pcs/ft ² :	2.13	
wt/pc:	12.5 lbs	5.7 kg
wt (lbs):	2506 /bdl	501 /sec

Rectangle



size:	178 x 118 x 60 mm	7.01 x 4.65 x 2.36 in
ft ² :	89.0 /bdl	14.9 /sec
pcs:	378 /bdl	63 /sec
lin ft:	150.1 /bdl	25.0 /sec
sec/bdl:	6	
pcs/ft ² :	4.24	
wt/pc:	6.3 lbs	2.9 kg
wt (lbs):	2381 /bdl	397 /sec

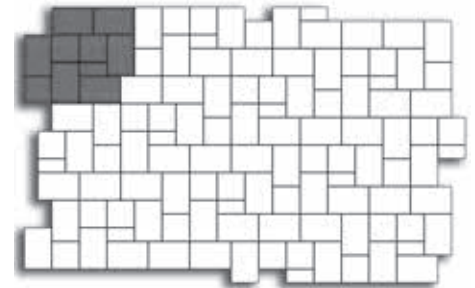

pattern 2: 3 Stone Random

- 72% rectangle
- 28% square bundle

notes: Bundle configuration may not exactly meet pattern requirements. Some cutting may be required.

Square Bundle



Square



Small Rectangle

size:	118 x 118 x 60 mm	4.65 x 4.65 x 2.36 in
pcs/ft ² :	6.35	
wt/pc:	4.1 lbs	1.9 kg
size:	118 x 58 x 60 mm	4.65 x 2.28 x 2.36 in
pcs/ft ² :	12.59	
wt/pc:	2.2 lbs	1.0 kg
ft ² :	89.5 /bdl	
pcs:	495* squares + 144* small rec /bdl (*Qty may vary)	
lin ft:	225.3	
sec/bdl:	1	
wt (lbs):	2349 /bdl	

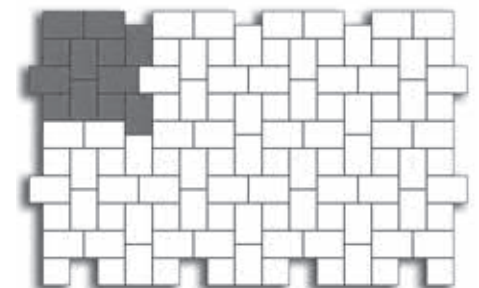

pattern 3: Modified Herringbone

- 75% rectangle
- 25% square bundle

notes: Use small rectangles at edges to minimize cutting or put two together to replace one square at various intervals throughout the pattern.

Circle Kit



size:	Various sizes at 60 mm (2.36 in) thick	
ft ² :	61.0 /bdl	
pcs/bdl:	96 - squares	144 - 3/4 stones
	200 - 15° wedges	32 - 45° wedges
	8 - center stones	
sec/bdl:	1	
wt/pc:	varies	
wt (lbs):	1566 /bdl	

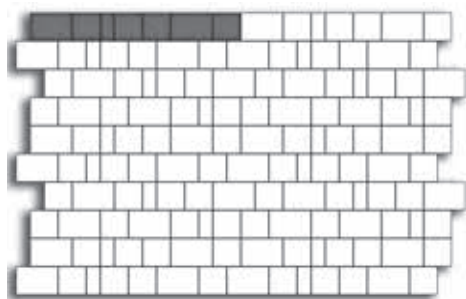

pattern 4: 3 Stone Runnerbond

40% rectangle
60% square bundle

notes: Use extra small rectangles at edges to minimize cutting.



pattern 5: Herringbone Weave

100% rectangle

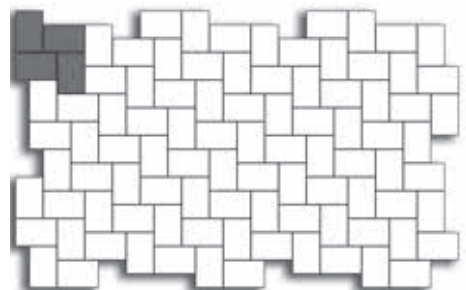

pattern 6: Herringbone

100% rectangle

notes: For superior results, mark off a true 90° angle before you begin laying the pavers.

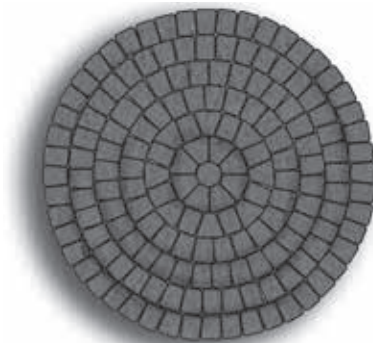

pattern 7: Circle Kit

100% circle kit

notes: Stratford Circle Kit creates one 2438 mm (8') diameter circle or two 1524 mm (5') diameter circles. Complete row-by-row instructions are available online.

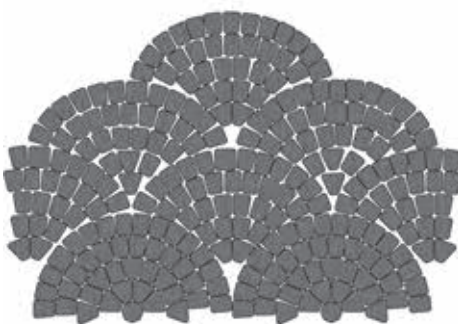

pattern 8: Fan

100% circle kit

notes: Begin laying fans at the center, working outward in rows.

Tips

Begin laying pavers at a corner, using a string or chalk line to keep lines straight.





Stratford does not have spacer bars. Leave a 1.5-3 mm (1/16-1/8 in) space around the paver to act as a joint.

To ensure proper color blending, take pieces from several bundles at once. Remove paving stones in stacks rather than in layers.

Install the main body of the installation, then go back and cut pieces to fill in the edges. Cut pieces less than one third their original size are likely to break. Cut two larger pieces instead.

Niagara offers two stone sizes, two thicknesses and a large color selection for design versatility.

Visit us online at www.navascape.ca for additional laying patterns.

-  pedestrian residential
-  pedestrian commercial
-  vehicular residential
-  vehicular commercial

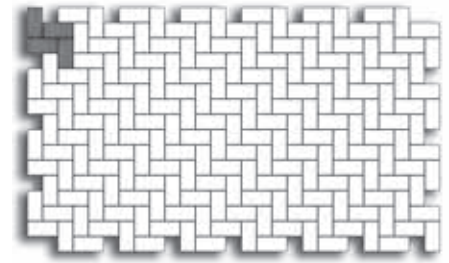

pattern 1: Herringbone

100% rectangle

notes: For superior results, mark off a true 90° angle before you begin laying the pavers.

Niagara 60



Rectangle†

size:	198 x 98 x 60 mm	7.80 x 3.86 x 2.36 in
ft²:	106.2 /bdl	17.7 /sec
pcs:	486 /bdl	81 /sec
lin ft:	161.0 /bdl	26.8 /sec
sec/bdl:	6	
pcs/ft²:	4.58	
wt/pc:	6.0 lbs	2.7 kg
wt (lbs):	2914 /bdl	486 /sec



Square

size:	198 x 198 x 60 mm	7.80 x 7.80 x 2.36 in
ft²:	94.0 /bdl	15.7 /sec
pcs:	216 /bdl	36 /sec
lin ft:	142.4 /bdl	23.7 /sec
sec/bdl:	6	
pcs/ft²:	2.30	
wt/pc:	12.1 lbs	5.4 kg
wt (lbs):	2607 /bdl	434 /sec

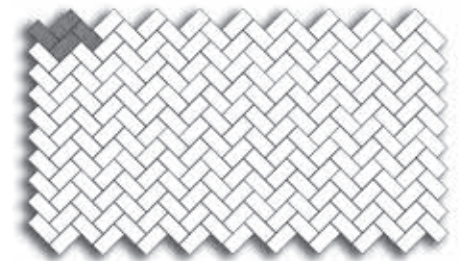

pattern 2: Herringbone Weave

100% rectangle

notes: Consider inserting a weave pattern into a larger area laid in the herringbone pattern for added interest.

Niagara 80



Rectangle

size:	198 x 98 x 80 mm	7.80 x 3.86 x 3.15 in
ft²:	94.4 /bdl	15.7 /sec
pcs:	432 /bdl	72 /sec
lin ft:	143.2 /bdl	23.9 /sec
sec/bdl:	6	
pcs/ft²:	4.58	
wt/pc:	7.8 lbs	3.5 kg
wt (lbs):	3371 /bdl	562 /sec



Square

size:	198 x 198 x 80 mm	7.80 x 7.80 x 3.15 in
ft²:	93.9 /bdl	15.7 /sec
pcs:	216 /bdl	36 /sec
lin ft:	142.4 /bdl	23.7 /sec
sec/bdl:	6	
pcs/ft²:	2.30	
wt/pc:	15.6 lbs	7.1 kg
wt (lbs):	3371 /bdl	562 /sec

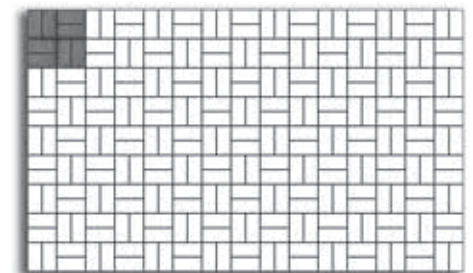

pattern 3: Parquet

100% rectangle

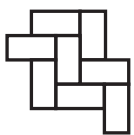

Herringbone for mechanical installation

size:	198 x 98 x 80 mm	7.80 x 3.86 x 3.15 in
ft²:	94.4 /bdl	
pcs:	432 /bdl	
lin ft:	n/a	
sec/bdl:	1	
pcs/ft²:	4.58	
wt/pc:	7.8 lbs	3.5 kg
wt (lbs):	3371 /bdl	

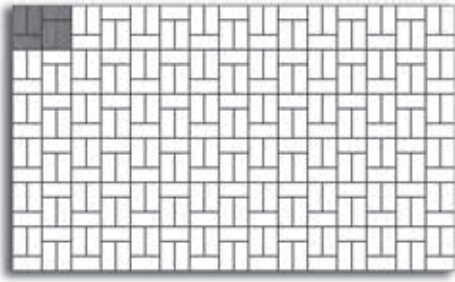
**pattern 4: Modified Parquet**

100% rectangle

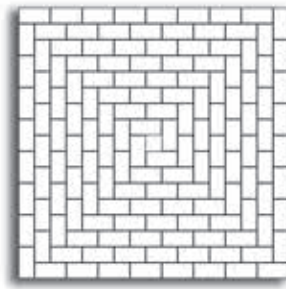
**pattern 7: Spiral**

100% rectangle

notes: Lay the entire area as a spiral or use it as an inset in a larger area laid in a different pattern. Rotate the inset spiral by 45° for added interest.

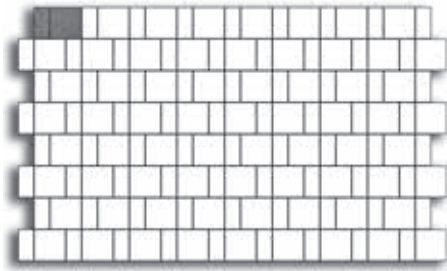
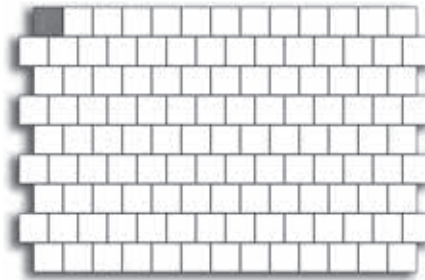
**pattern 5: Modified Runnerbond**67% square
33% rectangle**pattern 8: Offset Square**

100% square

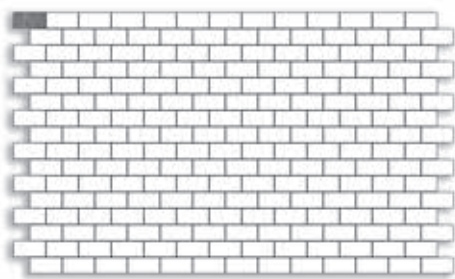
**pattern 6: Runnerbond**

100% rectangle

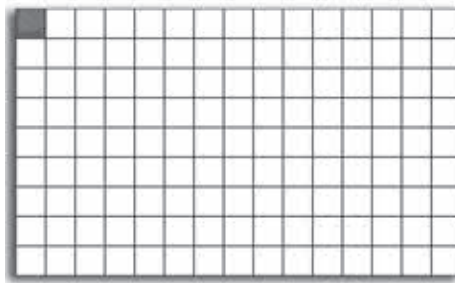
**pattern 9: Square**

100% square

notes: Rotate part of the area by 45° to create an interesting but subtle inlay. For a more dramatic effect, border the inlaid area with pavers in a different color.

Tips

Create distinct patterns by combining shapes, colors and patterns into unique installations.



Begin laying pavers at a corner, using a string or chalk line to keep lines straight.

To ensure proper color blending, take pieces from several bundles at once. Remove paving stones in stacks rather than in layers.

Install the main body of the installation, then go back and cut pieces to fill in the edges. Cut pieces less than one third their original size are likely to break. Cut two larger pieces instead.

Turfstone is an environmental solution for groundwater management and erosion control.

Visit us online at www.navascape.ca for additional laying patterns.

-  vehicular residential
-  vehicular commercial
-  permeable

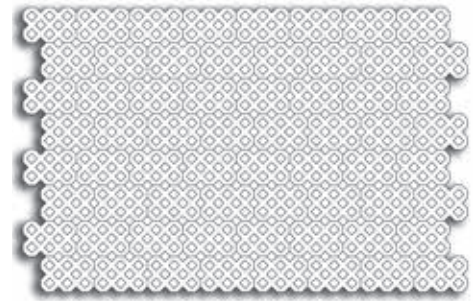

pattern 1: Runnerbond
100% turfstone

Turfstone 80



size:	398 x 598 x 80 mm	15.67 x 23.54 x 3.15 in
ft ² :	116.6 /bdl	
pcs:	45 /bdl	
lin ft:	n/a	
sec/bdl:	9	
ft ² /pc:	2.59	
wt/pc:	57.6 lbs	26.1 kg
wt (lbs):	2592 /bdl	

Turfstone 100



size:	398 x 598 x 100 mm	15.67 x 23.54 x 3.93 in
ft ² :	90.65 /bdl	
pcs:	35 /bdl	
lin ft:	n/a	
sec/bdl:	7	
ft ² /pc:	2.59	
wt/pc:	72.0 lbs	32.7 kg
wt (lbs):	2519 /bdl	



Roman Border has a textured surface and tapered shape for straight or curved accents and borders.

Visit us online at www.navascape.ca for additional laying patterns.

- PR

pedestrian residential
- PC

pedestrian commercial
- VR

vehicular residential

pattern 1: Curved Runnerbond

100% roman border

notes: Roman Border's tapered shape easily creates curves or circles with a minimum diameter of 2692 mm (8' 10") without cutting.

size:	184 x 119/136 x 60 mm	7.24 x 4.69/5.35 x 2.36 in
ft ² :	106.1 /bdl	17.7 /sec
pcs:	420 /bdl	70 /sec
lin ft:	180.0 /bdl	30.0 /sec
sec/bdl:	6	
pcs/ft ² :	3.96	
wt/pc:	6.9 lbs	3.1 kg
wt (lbs):	2880 /bdl	480 /sec

Roman Border

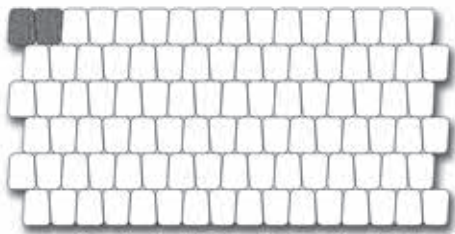

pattern 2: Straight Runnerbond

100% roman border

notes: Roman Border can easily create straight lines by alternating the direction of the blocks.

Traveno depicts all the beauty of natural travertine and is suitable for runnerbond patterns.

Visit us online at www.navascape.ca for additional laying patterns.

- PR — pedestrian residential PC — pedestrian commercial
- RT — rooftop paving

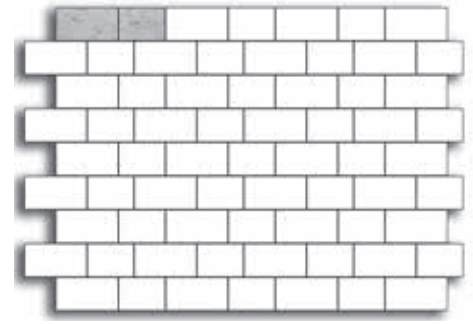

pattern 1: Modified Runnerbond

43% traveno 300 x 450 module
57% traveno 300 x 600 module

Traveno



300x450 Module

size:	297 x 447 x 45 mm	11.69 x 17.62 x 1.77 in
pcs:	50 /bdl	
ft ² :	71.5 /bdl	
ft ² /pc:	1.43	
wt/pc:	26.4 lbs	12.0 kg
wt (lbs):	1320 /bdl	



300x600 Module

size:	297 x 597 x 45 mm	11.69 x 23.5 x 1.77 in
pcs:	25 /bdl	
ft ² :	47.8 /bdl	
ft ² /pc:	1.91	
wt/pc:	38.5 lbs	17.5 kg
wt (lbs):	963 /bdl	

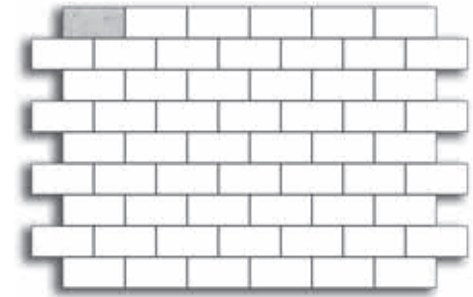

pattern 2: Runnerbond 1

100% traveno 300 x 600 module

Note: All paving slabs can be utilized in rooftop applications when set directly on roof system.

Recommmand min. 50 mm thickness when elevated on pedestal systems.

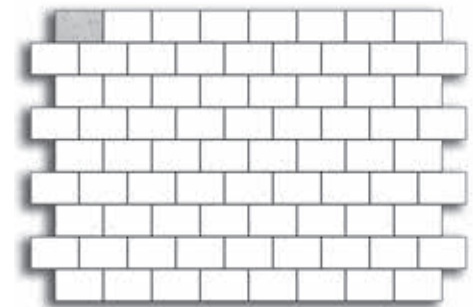

pattern 3: Runnerbond 2

100% traveno 300 x 450 module

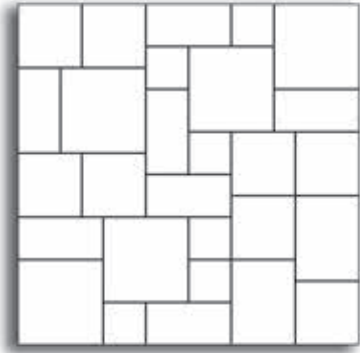

pattern 1: 5 Stone Random

100% valentia 5 stone random kit

notes: Random patterns must be installed with a 10 mm (0.4 in) joint between the tiles. When laid as shown, this kit creates a 2.44 x 2.44 m (8 x 8 ft) paved area with no cutting required.

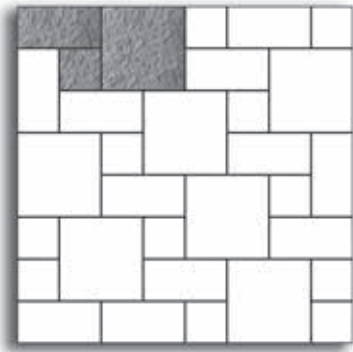

pattern 2: 3 Stone Random

100% valentia 3 stone random kit

notes: Random patterns must be installed with a 10 mm (0.4 in) joint between the tiles. When laid as shown, this kit creates a 2.44 x 2.44 m (8 x 8 ft) paved area with no cutting required.

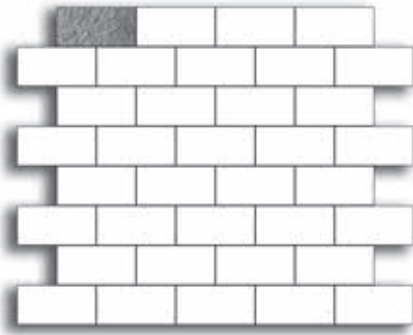

pattern 3: Runnerbond

100% valentia v2 module (300 x 600)

notes: Runnerbond patterns can be laid with stones butted tight together or with a joint, depending on your preference.

Valentia replicates natural limestone and can be used for runnerbond or random patterns.

Visit us online at www.navascape.ca for additional laying patterns.



pedestrian residential



pedestrian commercial

size:	600 x 600 x 45 mm	23.62 x 23.62 x 1.77 in
ft ² /pc:	3.87	
wt/pc:	70.4 lbs	32.0 kg
size:	295 x 600 x 45 mm	11.61 x 23.62 x 1.77 in
ft ² /pc:	1.90	
wt/pc:	36.3 lbs	16.5 kg
size:	447.5 x 600 x 45 mm	17.62 x 23.62 x 1.77 in
ft ² /pc:	2.89	
wt/pc:	56.0 lbs	25.5 kg
size:	447.5 x 447.5 x 45 mm	17.62 x 17.62 x 1.77 in
ft ² /pc:	2.16	
wt/pc:	42.0 lbs	19.0 kg
size:	295 x 295 x 45 mm	11.61 x 11.61 x 1.77 in
ft ² /pc:	0.94	
wt/pc:	16.5 lbs	7.5 kg
pcs:	5 V1 + 7 V2 + 2 V3 + 8 V4 + 6 V5 /bdl	
ft ² :	64.0 /bdl	
wt (lbs):	1153 /bdl	

size:	600 x 600 x 45 mm	23.62 x 23.62 x 1.77 in
ft ² /pc:	3.87	
wt/pc:	70.4 lbs	32.0 kg
size:	295 x 600 x 45 mm	11.61 x 23.62 x 1.77 in
ft ² /pc:	1.90	
wt/pc:	36.3 lbs	16.5 kg
size:	295 x 295 x 45 mm	11.61 x 11.61 x 1.77 in
ft ² /pc:	0.94	
wt/pc:	16.5 lbs	7.5 kg
pcs:	7 V1 + 12 V2 + 12 V5 /bdl	
ft ² :	64.0 /bdl	
wt (lbs):	1126 /bdl	

size:	295 x 600 x 45 mm	11.61 x 23.62 x 1.77 in
pcs:	25 /bdl	
ft ² :	47.5 /bdl	
ft ² /pc:	1.90	
wt/pc:	36.3 lbs	16.5 kg
wt (lbs):	908 /bdl	

5 Stone Random Kit



V1 Module



V2 Module



V3 Module



V4 Module



V5 Module

3 Stone Random Kit



V1 Module



V2 Module



V5 Module

V2 Module



Abruzzo has a naturally rugged texture and can be used to create a variety of patterns.

Visit us online at www.navascape.ca for additional laying patterns.

- PR — pedestrian residential
- PC — pedestrian commercial
- RT — rooftop paving

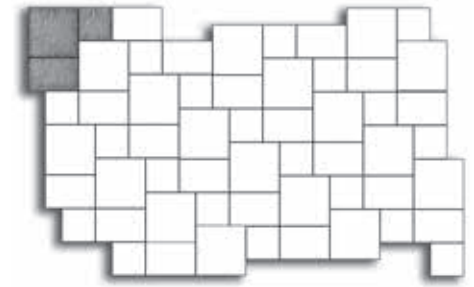

Abruzzo 40



400x400 Module

size:	400 x 400 x 40 mm	15.75 x 15.75 x 1.57 in
pcs:	56 /bdl	
ft ² :	96.3 /bdl	
ft ² /pc:	1.72	
wt/pc:	32.0 lbs	14.5 kg
wt (lbs):	1791 /bdl	



400x600 Module

size:	400 x 600 x 40 mm	15.75 x 23.62 x 1.57 in
pcs:	56 /bdl	
ft ² :	144.5 /bdl	
ft ² /pc:	2.58	
wt/pc:	48.3 lbs	21.9 kg
wt (lbs):	2706 /bdl	



600x600 Module

size:	600 x 600 x 40 mm	23.62 x 23.62 x 1.57 in
pcs:	28 /bdl	
ft ² :	108.4 /bdl	
ft ² /pc:	3.87	
wt/pc:	72.1 lbs	32.7 kg
wt (lbs):	2018 /bdl	

pattern 1: 3 Tile Herringbone

- 21% stonetile 400 x 400 module
- 32% stonetile 400 x 600 module
- 47% stonetile 600 x 600 module

notes: This pattern can be achieved with StoneTile Abruzzo, Piazza or Tuscanni.

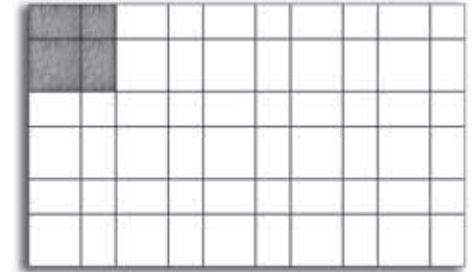

pattern 2: Stone Cross

- 16% stonetile 400 x 400 module
- 48% stonetile 400 x 600 module
- 36% stonetile 600 x 600 module

notes: This pattern can be achieved with StoneTile Abruzzo, Piazza or Tuscanni.

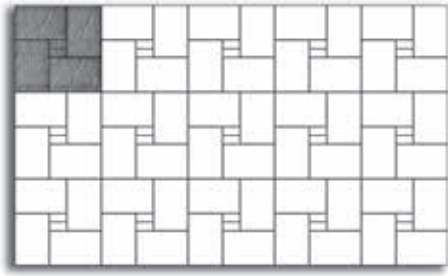

pattern 3: Tile Weave

96% stonetile 300 x 450 module
 4% english cobble or rosedale square

OR

96% stonetile 400 x 600 module
 4% niagara rectangle or square

notes: This pattern can be achieved with StoneTile Abruzzo, Piazza or Tuscanni.

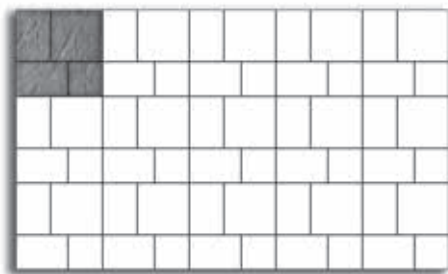

pattern 4: Rotating Cube

16% stonetile 400 x 400 module
 48% stonetile 400 x 600 module
 36% stonetile 600 x 600 module

notes: For a more random appearance, rotate the cube each time it is repeated. This pattern can be achieved with StoneTile Abruzzo, Piazza or Tuscanni.



pattern 5: Herringbone Weave

100% any rectangular StoneTile module

notes: This pattern can be achieved with StoneTile Abruzzo, Piazza or Tuscanni.

Tuscanni emulates the irregular, ridged surface of natural stone and can create a variety of patterns.

Visit us online at www.navascape.ca for additional laying patterns.



pedestrian residential



pedestrian commercial



rooftop paving

size:	400 x 400 x 40 mm	15.75 x 15.75 x 1.57 in
pcs:	56 /bdl	
ft ² :	96.3 /bdl	
ft ² /pc:	1.72	
wt/pc:	32.0 lbs	14.5 kg
wt (lbs):	1791 /bdl	

Tuscanni 40



400x400 Module

size:	400 x 600 x 40 mm	15.75 x 23.62 x 1.57 in
pcs:	56 /bdl	
ft ² :	144.5 /bdl	
ft ² /pc:	2.58	
wt/pc:	48.3 lbs	21.9 kg
wt (lbs):	2706 /bdl	



400x600 Module

size:	600 x 600 x 40 mm	23.62 x 23.62 x 1.57 in
pcs:	28 /bdl	
ft ² :	108.4 /bdl	
ft ² /pc:	3.87	
wt/pc:	72.1 lbs	32.7 kg
wt (lbs):	2018 /bdl	



600x600 Module

Piazza has a smooth surface and vibrant colors for dramatic pattern possibilities.

Visit us online at www.navascape.ca for additional laying patterns.

- PR — pedestrian residential
- PC — pedestrian commercial
- RT — rooftop paving

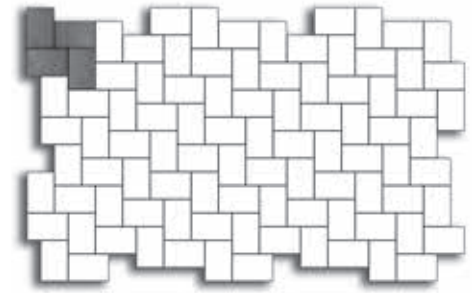

pattern 6: Herringbone

100% any rectangular StoneTile module

notes: For superior results, mark off a true 90° angle before you begin. This pattern can be achieved with StoneTile Abruzzo, Piazza or Tuscanni.

Piazza 40



400x400 Module

size:	400 x 400 x 40 mm	15.75 x 15.75 x 1.57 in
pcs:	56 /bdl	
ft²:	96.3 /bdl	
ft²/pc:	1.72	
wt/pc:	32.0 lbs	14.5 kg
wt (lbs):	1791 /bdl	



400x600 Module

size:	400 x 600 x 40 mm	15.75 x 23.62 x 1.57 in
pcs:	56 /bdl	
ft²:	144.5 /bdl	
ft²/pc:	2.58	
wt/pc:	48.3 lbs	21.9 kg
wt (lbs):	2706 /bdl	



600x600 Module

size:	600 x 600 x 40 mm	23.62 x 23.62 x 1.57 in
pcs:	28 /bdl	
ft²:	108.4 /bdl	
ft²/pc:	3.87	
wt/pc:	72.1 lbs	32.7 kg
wt (lbs):	2018 /bdl	

StoneTile Piazza is also available in the Impresa finish, a distinctive, “aged” texture which gives the tiles a natural, weathered look. Impresa finish can be applied to the entire stone or as a pattern on the stone, dramatically increasing the design possibilities.

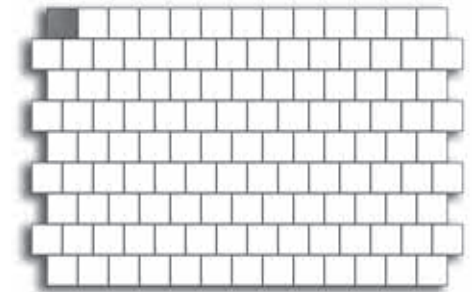

pattern 7: Offset Square

100% any square StoneTile module

notes: This pattern can be achieved with StoneTile Abruzzo, Piazza or Tuscanni.

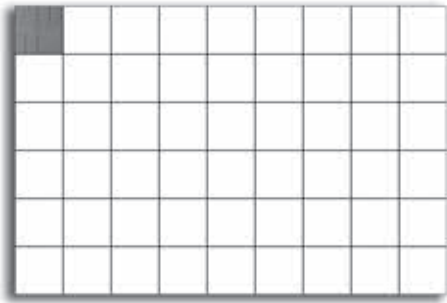

pattern 1: Square

100% any square paver slab

notes: This pattern is suitable for SmartCast or Brick Impression.

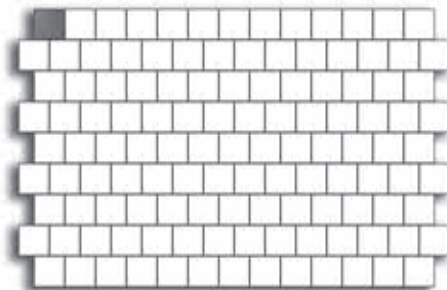

pattern 2: Offset Square

100% any square unit

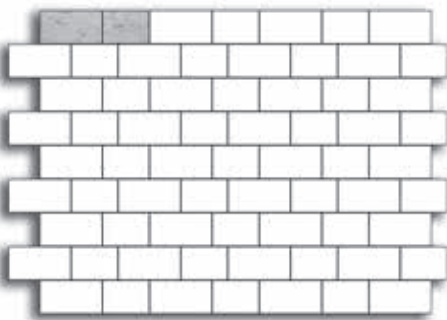



pattern 3: Modified Runnerbond

40% SmartCast diamond 600 x 750

60% SmartCast diamond 600 x 600

With a variety of classic designs, Navascape paver slabs are a simple and affordable paving solution.

Visit us online at www.navascape.ca for additional laying patterns.

-  pedestrian residential
-  pedestrian commercial
-  rooftop paving

size:	600 x 600 x 40 mm	23.62 x 23.62 x 1.57 in
pcs:	28 /bdl	
ft ² :	108.4 /bdl	
ft ² /pc:	3.87	
wt/pc:	74.5 lbs	33.8 kg
wt (lbs):	2086 /bdl	

SmartCast Diamond



600x600 Module

size:	600 x 750 x 40 mm	23.62 x 29.53 x 1.57 in
pcs:	28 /bdl	
ft ² :	135.5 /bdl	
ft ² /pc:	4.84	
wt/pc:	97.3 lbs	44.1 kg
wt (lbs):	2723 /bdl	



600x750 Module

size:	400 x 400 x 40 mm	15.75 x 15.75 x 1.57 in
pcs:	56 /bdl	
ft ² :	96.3 /bdl	
ft ² /pc:	1.72	
wt/pc:	30.9 lbs	14.0 kg
wt (lbs):	1733 /bdl	

SmartCast Brick



400x400 Module

size:	600 x 600 x 40 mm	23.62 x 23.62 x 1.57 in
pcs:	28 /bdl	
ft ² :	108.4 /bdl	
ft ² /pc:	3.87	
wt/pc:	74.5 lbs	33.8 kg
wt (lbs):	2086 /bdl	



600x600 Module

Smart Cast Clean & Reflect

Visit us online at www.navascape.ca for additional laying patterns.

- PR — pedestrian residential PC — pedestrian commercial
- RT — rooftop paving

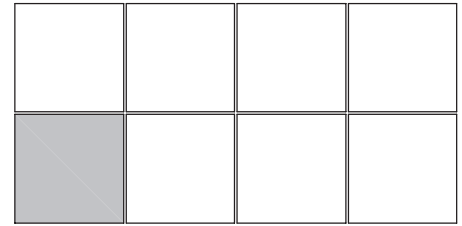

pattern 1: Square
100% Smart Cast



SmartCast Clean

size: **600 x 600 x 50 mm** **23.62 x 23.62 x 1.97 in**
 pcs: 22 /bdl
 ft²: 85.10 /bdl
 ft²/pc: 3.87
 wt/pc: 93 lbs
 wt/(lbs): 2046 lbs



SmartCast Reflect

size: **600 x 600 x 50 mm** **23.62 x 23.62 x 1.97 in**
 pcs: 22 /bdl
 ft²: 85.10 /bdl
 ft²/pc: 3.87
 wt/pc: 93 lbs
 wt/(lbs): 2046 lbs

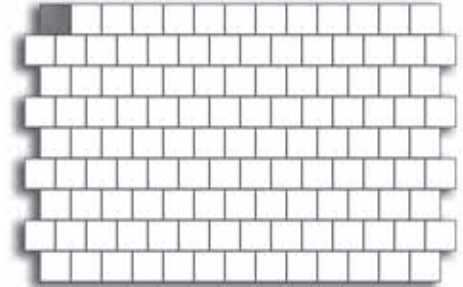

pattern 2: Offset Square
100% Smart Cast



SmartCast Diamond Roof

size: **600 x 600 x 50 mm** **23.62 x 23.62 x 1.97 in**
 pcs: 22 /bdl
 ft²: 85.10 /bdl
 ft²/pc: 3.87
 wt/pc: 93 lbs
 wt/(lbs): 2046 lbs



Built-in-Pedestal

All 50 mm (1.97 in) roof top paving slabs are available with a built-in pedestal option as a special order (Minimum order quantities apply). Call For Details.

At Navascape, quality manufacturing is our first priority. We insist on beauty backed by durability for all of our paving products. Our products are made to meet or exceed the CSA and ASTM specifications listed below.

Visit us online at www.navascape.ca for full product specifications.

Pavers

These specifications apply to all interlocking concrete pavers manufactured by Navascape.

In Canada: CSA A231.2 - 06 Precast Concrete Pavers

Materials: Colour, Cement, Aggregates, Admixtures, Water all meet applicable CSA standards

Physical: Compressive Strength - Minimum average of 5 cubes cut from pavers to be 50 MPa with no individual cube below 45 MPa
Durability - Average loss of 3 full size pavers to be less than 225 g/m² of surface area after 28 freeze-thaw cycles or less than 500 g/m² of surface area after 49 freeze-thaw cycles immersed in 3% saline solution

Tolerances: All paver dimensions are to be within permissible tolerance (prior to post manufacturing treatment, if applicable):

- i) length and width: -1.0 mm to +1.6 mm (-1/32" to +1/16")
- ii) height: ±3.0 mm (±1/8")

Architectural Tiles & Paver Slabs

These specifications apply to all architectural tiles and concrete paver slabs manufactured by Navascape.

In Canada: CSA A231.1 - 06 Precast Concrete Paving Slabs

Materials: Colour, Cement, Aggregates, Admixtures, Water all meet applicable CSA standards

Physical: Flexural Strength - Minimum average of 3 slabs to be 4.5 MPa with no individual unit below 4.0 MPa
Durability (Tiles) - Average loss of mass of 3 samples to be less than 500 g/m² of surface area after 28 freeze-thaw cycles or less than 1200 g/m² of surface area after 49 freeze-thaw cycles.
Durability (Slabs) - Average loss of mass of 3 samples to be less than 300 g/m² of surface area after 28 freeze-thaw cycles or less than 800 g/m² of surface area after 49 freeze-thaw cycles

Tolerances: All tile/paver slab dimensions are to be within permissible tolerance (prior to post manufacturing treatment, if applicable):

- i) length and width: -1 mm to +2 mm (-1/32" to +1/16")
- ii) height: ±3 mm (±1/8")
- iii) warpage (convex or concave): ≤450 mm (18") : 2 mm (1/16"); > 450 mm (18") : 3 mm (1/8")

Antique RB Wall comes complete with tapered and corner units and several coping options.

Visit us online at www.navascape.ca
for additional information and standard engineering.

Recommended Wall Height up to 3.4 m (11')
Engineering required for walls greater than 1.0m (3.3 ft.)

Standard Unit



size:	150 x 300 x 200 mm	5.91 x 11.81 x 7.87 in
pcs:	60 /bdl	
ft ² :	19.4 /bdl	
lin ft:	39.4 /bdl	
pcs/ft ² :	3.1	
wt/pc:	44.5 lbs	20.2 kg
wt (lbs):	2667 /bdl	

Tapered Unit



size:	150x300x200/150 mm	5.91x11.81x7.87/5.91 in
pcs:	48 /bdl	
ft ² :	15.5 /bdl	
lin ft:	31.5 /bdl	
pcs/ft ² :	3.1	
wt/pc:	41.6 lbs	18.9 kg
wt (lbs):	1995 /bdl	

Corner Unit



size:	150 x 300 x 200 mm	5.91 x 11.81 x 7.87 in
pcs:	30 /bdl	
wt/pc:	45.3 lbs	20.6 kg
wt (lbs):	1360 /bdl	

10" Coping



size:	75 x 300 x 250 mm	2.95 x 11.81 x 9.84 in
pcs:	96 /bdl	
lin ft:	78.7 /bdl	
wt/pc:	26.9 lbs	12.2 kg
wt (lbs):	2584 /bdl	

Tapered Coping



size:	75x335x215/187 mm	2.95x13.19x8.46/7.36 in
pcs:	96 /bdl	
lin ft:	67.7* /bdl	(*Based on maximum yield)
wt/pc:	24.3 lbs	11.0 kg
wt (lbs):	2335 /bdl	

Antique Bullnose Coping



size:	70 x 317 x 150 mm	2.76 x 12.48 x 5.91 in
pcs:	120 /bdl	40 /sec
lin ft:	59.1 /bdl	19.7 /sec
sec/bdl:	3	
wt/pc:	15.5 lbs	7.0 kg
wt (lbs):	1860 /bdl	620 /sec

Features

All Antique RB Wall component units come pre-split.

Tapered Units create a 2134 mm (7') outside radius without cutting.

Antique Bullnose Coping is an attractive and functional solution for wall coping, pool coping and stair treads.

Tips

16 Tapered Units are required for a rounded 90° corner, 66 pcs for a full circle.

10" Coping bundles include several closed-end units (left and right). Save these units for the ends of your wall to give it a finished appearance.

Build vertical walls by knocking off the back half of each of the two ribs on top of the block using a hammer and chisel.

Antique Kassel Wall has a split face on both sides for courtyard and other freestanding walls.

Visit us online at www.navascape.ca for additional information and standard engineering.

Recommended Wall Height up to 1 m (3')

size:	150 x 300 x 200 mm	5.91 x 11.81 x 7.87 in
pcs:	60 /bdl	
ft ² :	19.4 /bdl	
lin ft:	39.4 /bdl	
pcs/ft ² :	3.1	
wt/pc:	46.0 lbs	20.9 kg
wt (lbs):	2760 /bdl	

Standard Unit



size:	150 x 300 x 200 mm	5.91 x 11.81 x 7.87 in
pcs:	30 /bdl	
wt/pc:	49.0 lbs	22.2 kg
wt (lbs):	1470 /bdl	

End Unit



size:	75 x 355 x 300 mm	2.95 x 13.98 x 11.81 in
pcs:	72 /bdl	
lin ft:	70.9 /bdl	
wt/pc:	40.0 lbs	18.1 kg
wt (lbs):	2880 /bdl	

Kassel Stone Coping



Features

All Antique Kassel Wall component units come pre-split and double sided.

Tips

Freestanding walls may be subject to height regulations. Consult your local building code before beginning construction.

End Units should be cut to stagger wall joints between courses.

Kassel Stone Coping bundles include several closed-end units (left and right). Save these units for the ends of your wall to give it a finished appearance.

Antique Hampton Wall offers six different face options to create standard or patterned walls.
 Visit us online at www.navascape.ca
 for additional information and standard engineering.

Recommended Wall Height up to 0.8 m (2'8")

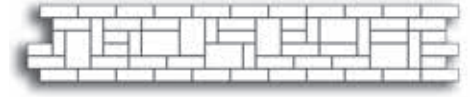

pattern 1: Hampton Wall Art 1

notes: Create wall art by rotating blocks within the wall for random or repeating patterns.

Antique Hampton Wall



size:	100 x 200 x 300 mm	3.93 x 7.87 x 11.81 in
pcs:	96 /bdl	
ft ² :	30.9* /bdl	(*Based on 100x300 (4x12) face exposed)
lin ft:	94.5* /bdl	(*Based on 100x300 (4x12) face exposed)
pcs/ft ² :	3.1	(*Based on 100x300 (4x12) face exposed)
wt/pc:	30.6 lbs	13.9 kg
wt (lbs):	2939 /bdl	

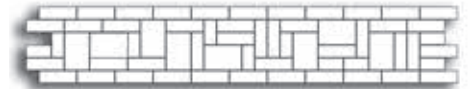

pattern 2: Hampton Wall Art 2

notes: Consider recessing blocks to further add a unique appearance.

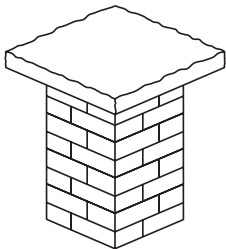

Antique Hampton Wall easily creates columns and pillars with a single block. Run electrical conduit up through the center to create elegant light standards. Top with a Valentia Pier Cap for a natural finishing touch.

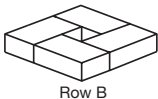
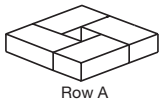

Antique Tudor Wall has a unique face texture and is ideal for straight or curved garden walls.
 Visit us online at www.navascape.ca
 for additional information and standard engineering.

Recommended Wall Height up to 0.5 m (1'8")

Antique Tudor Wall



size:	100x200x225/150 mm	3.93x7.87x8.86/5.91 in
pcs:	100 /bdl	
ft ² :	24.2* /bdl	(*Based on maximum yield)
lin ft:	73.8* /bdl	(*Based on maximum yield)
pcs/ft ² :	4.1*	(*Based on maximum yield)
wt/pc:	19.2 lbs	8.7 kg
wt (lbs):	1918 /bdl	

Features

Antique Hampton Wall is a single unit that provides six different face options to create random or repeating patterns within your wall.

All Antique Tudor Wall units are double sided and reversible for inside and outside curves.

Antique Tudor Wall units create a 600 mm (24") outside radius without cutting.

Tips

Antique Hampton Wall can be stacked vertically up to 5 courses high or stacked with a 25 mm (1") setback per course to 8 courses high.

Antique Tudor Wall can be stacked vertically up to 4 courses high or stacked with a 25 mm (1") setback per course to 5 courses high.

4 Antique Tudor Wall units are required for a rounded 90° corner, 17 pcs for a full circle.

RB Wall comes complete with tapers, corner units and several coping options for straight or curved walls.

Visit us online at www.navascape.ca for additional information and standard engineering.

Recommended Wall Height up to 3.4 m (11')
Engineering required for walls greater than 1.0m (3.3 ft.)

Features

Most RB Wall component units come unsplit. Corner Units, Tapered Coping and Bullnose Coping are sold as single, pre-split units.

Tapered Units and Tapered Coping create a 2134 mm (7') outside radius without cutting.

Bullnose Coping is an attractive and functional solution for wall coping, pool coping and stair treads.

Tips

16 tapered units are required for a rounded 90° corner, 66 pcs for a full circle.

10" Coping bundles and Tapered Coping bundles each include 16 closed-end units (8 left, 8 right). Save these units for the ends of your wall to give it a finished appearance.

Build vertical walls by knocking off the back half of each of the two ribs on top of the block using a hammer and chisel.

size:	150 x 300 x 200 mm	5.91 x 11.81 x 7.87 in
pcs:	60 /bdl	(30 double units)
ft ² :	19.4 /bdl	
lin ft:	39.4 /bdl	
pcs/ft ² :	3.1	
wt/pc:	44.7 lbs	20.3 kg
wt (lbs):	2682 /bdl	

Standard Unit



size:	150x300x200/150 mm	5.91x11.81x7.87/5.91 in
pcs:	60 /bdl	(30 double units)
ft ² :	19.4 /bdl	
lin ft:	39.4 /bdl	
pcs/ft ² :	3.1	
wt/pc:	40.4 lbs	18.3 kg
wt (lbs):	2422 /bdl	

Tapered Unit



size:	150 x 300 x 200 mm	5.91 x 11.81 x 7.87 in
pcs:	36 /bdl (18 left, 18 right)	
wt/pc:	46.2 lbs	21.0 kg
wt (lbs):	1664 /bdl	

Corner Unit



size:	75 x 300 x 250 mm	2.95 x 11.81 x 9.84 in
pcs:	96 /bdl	(48 double units)
lin ft:	78.7 /bdl	
wt/pc:	26.7 lbs	12.1 kg
wt (lbs):	2560 /bdl	

10" Coping



size:	75 x 300 x 610 mm	2.95 x 11.81 x 24.02 in
pcs:	32 /bdl	(16 double units)
lin ft:	64.0 /bdl	
wt/pc:	67.5 lbs	30.6 kg
wt (lbs):	2161 /bdl	

24" Coping



size:	75.335x215/187 mm	2.95x13.19x8.46/7.36 in
pcs:	96 /bdl	
lin ft:	67.7* /bdl	(*Based on maximum yield)
wt/pc:	24.3 lbs	11.0 kg
wt (lbs):	2335 /bdl	

Tapered Coping



size:	70 x 317 x 150 mm	2.76 x 12.48 x 5.91 in
pcs:	90 /bdl	30 /sec
lin ft:	44.3 /bdl	14.8 /sec
sec/bdl:	3	
wt/pc:	15.5 lbs	7.0 kg
wt (lbs):	1389 /bdl	463 /sec

Bullnose Coping



Wallstone and Wedgestone Wall can be used separately or in combination for greater flexibility.

Visit us online at www.navascape.ca for additional information and standard engineering.

Recommended Wall Height (Wallstone) up to 2.6 m (8')
Engineering required for walls greater than 1.0m (3.3 ft.)

Recommended Wall Height (Wedgestone) up to 0.7 m (2'4")



pattern 1: Wall Art 1

notes: Place Wallstone Standard Units vertically and horizontally to create interesting patterns within the wall.

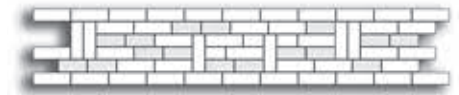

pattern 2: Wall Art 2

notes: Add an additional dimension to your wall by including Wedgestone Wall units in your pattern (shaded). Consider recessing blocks to add further distinction. Except for the coping course, it is not recommended to set modules forward beyond the front of the base course.

Wallstone



Standard Unit

size:	100 x 200 x 300 mm	3.93 x 7.87 x 11.81 in
pcs:	108 /bdl	
ft ² :	34.8 /bdl	
lin ft:	106.3 /bdl	
pcs/ft ² :	3.1	
wt/pc:	28.9 lbs	13.1 kg
wt (lbs):	3118 /bdl	



Double Unit[†]
[†]Special Order

size:	100 x 400 x 300 mm	3.93 x 15.75 x 11.81 in
pcs:	54 /bdl	
ft ² :	17.4 /bdl	
lin ft:	53.1 /bdl	
pcs/ft ² :	3.1	
wt/pc:	57.8 lbs	26.2 kg
wt (lbs):	3118 /bdl	



Triple Unit[†]
[†]Special Order

size:	100 x 600 x 300 mm	3.93 x 23.62 x 11.81 in
pcs:	36 /bdl	
ft ² :	11.6 /bdl	
lin ft:	35.4 /bdl	
pcs/ft ² :	3.1	
wt/pc:	86.7 lbs	39.3 kg
wt (lbs):	3118 /bdl	



12" Coping

size:	100 x 200 x 300 mm	3.93 x 7.87 x 11.81 in
pcs:	108 /bdl	
lin ft:	106.3 /bdl	
wt/pc:	28.9 lbs	13.1 kg
wt (lbs):	3118 /bdl	

Wedgestone Wall



Standard Unit

size:	100x200x231/153 mm	3.93x7.87x9.09/6.02 in
pcs:	150 /bdl	
ft ² :	37.2* /bdl	(*Based on maximum yield)
lin ft:	113.6* /bdl	(*Based on maximum yield)
pcs/ft ² :	4*	(*Based on maximum yield)
wt/pc:	18.4 lbs	8.4 kg
wt (lbs):	2765 /bdl	



Coping Unit

size:	100x200x231/153 mm	3.93x7.87x9.09/6.02 in
pcs:	150 /bdl	
lin ft:	113.6* /bdl	(*Based on maximum yield)
wt/pc:	18.4 lbs	8.4 kg
wt (lbs):	2765 /bdl	

Features

Suitable for gravity or grid, vertical or setback, straight or curved walls.

All Wallstone and Wedgestone Wall component units come pre-split.

End grooves on Wallstone Standard Units maintain interlock between courses, even when placed vertically. 2/3 of Standard Units are also double rock-faced.

Wedgestone Wall units are 100% double rock-faced and reversible for inside and outside curves. Units create a 600 mm (2') outside radius without cutting.

Tips

4 Wedgestone Wall units are required for a rounded 90° corner, 16 pcs for a full circle.

Patterned Wallstone walls can be stacked vertically up to 6 courses high (7 courses if using a Wallstone Double Unit in the base) or up to 8 courses if 50% of units have at least a one groove setback and a Wallstone Double Unit is used in the base course.

Wall stone & Wedgeston wall

Visit us online at www.navascape.ca
for additional information and standard engineering.

size: **100 x 200 x 300 mm** **7.87 x 11.81 x 3.93 in**
 pcs: 36 /bdl
 wt/pc: 28.90 lbs
 wt (lbs): 1040 lbs



Corner/Column unit

size: **100 x 300 x 450 mm** **3.93 x 11.81 x 17.72 in**
 pcs: 48 /bdl
 lin ft: 70.90 /bdl
 wt/pc: 64.80 lbs
 wt (lbs): 3118 /lbs



18" Coping

size: **95 x 184 x 285/210 mm** **3.74 x 7.24 x 11.22/8.25 in**
 pcs: 144 /bdl
 ft²: 42.0 /bdl
 lin ft: 134.60
 pcs/ft²: 3.43
 wt/pc: 20.30 lbs
 wt (lbs): 2921 lbs



Triwedge wall
Standard unit

GRANDE is a massive block system capable of building retaining walls to virtually any height.

Visit us online at www.navascape.ca for additional information and standard engineering.

Recommended Wall Height up to 16 m (50') and higher
Engineering required for walls greater than 1.0m (3.3 ft.)

GRANDE Wall



375 Standard†
†Special Order

size:	200 x 375 x 1000 mm	7.87 x 14.76 x 39.4 in
pcs:	9 /bdl	
ft²:	19.4 /bdl	
lin ft:	29.6 /bdl	
pcs/ft²:	0.46	
wt/pc:	355 lbs	161 kg
wt (lbs):	3195 /bdl	



750 Standard†
†Special Order

size:	200 x 750 x 1000 mm	7.87 x 29.52 x 39.4 in
pcs:	4 /bdl	
ft²:	8.6 /bdl	
lin ft:	13.1 /bdl	
pcs/ft²:	0.46	
wt/pc:	710 lbs	322 kg
wt (lbs):	2840 /bdl	



1125 Standard†
†Special Order

size:	200 x 1125 x 1000 mm	7.87 x 44.29 x 39.4 in
pcs:	3 /bdl	
ft²:	6.5 /bdl	
lin ft:	9.9 /bdl	
pcs/ft²:	0.46	
wt/pc:	1065 lbs	483 kg
wt (lbs):	3195 /bdl	



438 Coping/Step

size:	200 x 438 x 1000 mm	7.87 x 17.24 x 39.4 in
pcs:	6 /bdl	
lin ft:	19.7 /bdl	
wt/pc:	380 lbs	172 kg
wt (lbs):	2280 /bdl	

GRANDE Wedge



Standard Unit

size:	200x312.5x380/250mm	7.87x12.3x14.96/9.84in
pcs:	36 /bdl	
ft²:	29.5* /bdl	(*Based on maximum yield)
lin ft:	44.9* /bdl	(*Based on maximum yield)
pcs/ft²:	1.2*	(*Based on maximum yield)
wt/pc:	82.9 lbs	37.6 kg
wt (lbs):	2985 /bdl	



Coping Unit

size:	100x312.5x380/250mm	3.93x12.3x14.96/9.84in
pcs:	63 /bdl	
lin ft:	78.5* /bdl	(*Based on maximum yield)
wt/pc:	46.5 lbs	21.1 kg
wt (lbs):	2933 /bdl	



200 x 500 x 1000
Corner unit

size:	200 x 500 x 1000 mm	7.87 x 19.69 x 39.4 in
pcs:	6 /bdl	
ft²:	19.38 /bdl	
wt/pc:	469 lbs	
wt (lbs):	2814 lbs	

Features

Suitable for gravity or grid, vertical or setback, straight or curved walls.

All GRANDE Wall component units come pre-split.

Patented tongue and groove technology provides the strongest interlock and grid connectivity available.

Ideal for narrow construction envelopes or where grid is not permitted.

Corners are available cut at any angle.

438 Coping/Step Unit is ideal for standalone stairs.

Wedge Units create a 1000 mm (3'3") outside radius without cutting.

Tips

4 Wedge Units are required for a rounded 90° corner, 16 pcs for a full circle.

Two thirds of all Wedge Units in a bundle come double rock-faced for inside and outside curves.

Grande 375 standard units come double rock face 1/3 of bundle

At Navascape, quality manufacturing is our first priority. We insist on strength and beauty backed by durability for all of our retaining wall products. Our products are manufactured to meet or exceed the CSA and ASTM specifications listed below.

Visit us online at www.navascape.ca for full product specifications.

Segmental Retaining Walls

These specifications apply to RB Wall, Antique Kassel Wall, Wallstone & Wedgestone Wall, Antique Hampton wall, Antique RB wall and Antique Tudor wall.

In Canada:

Materials: Colour, Cement, Aggregates, Admixtures, Water all meet applicable CSA standards

Physical: Compressive Strength - Average of 3 cubes cut from units to be greater than 21 MPa with no individual coupon below 18 MPa when tested in accordance with CSA A 231.2
Absorption - Average of 3 specimens to be less than 8% when tested in accordance with CSA A 165 - Series
Durability - Average loss of 3 units not greater than 800 g/m² of surface area after 30 freeze-thaw cycles immersed in a 3% saline solution when tested in accordance with OPSS 1352

Tolerances: All dimensions are to be within permissible tolerance (prior to post manufacturing treatment, if applicable):
i) length, width and height: ± 3.2 mm ($\pm 1/8$ ")

GRANDE Wall Segmental Retaining Wall

In Canada:

Materials: Colour, Cement, Aggregates, Admixtures, Water all meet applicable CSA standards

Physical: Compressive Strength - Minimum average of 3 coupons cut from units to be 30 MPa with no individual coupon below 27 MPa when tested in accordance with ASTM C 140
Absorption - Average of 3 specimens to be less than 6% with no individual unit greater than 7% when tested in accordance with CSA A 165 - Series
Durability - Average loss of 3 specimens to be less than 600 g/m² after 50 freeze-thaw cycles immersed in a 3% saline solution when tested in accordance with OPSS 1352

Tolerances: All dimensions are to be within permissible tolerance:
i) length and width: ± 5 mm ($\pm 3/16$ ") ii) height: ± 5 mm ($\pm 5/16$ ")

Navascape retaining wall products are designed for superior performance with engineered strength and versatility. Most of our wall systems can be built with grid or without (gravity), vertically or with a setback (battered), straight or curved - whatever your project demands. A variety of design and assembly options are illustrated on these pages.

Visit us online at www.navascape.ca for complete standard engineering drawings.

Battered Walls

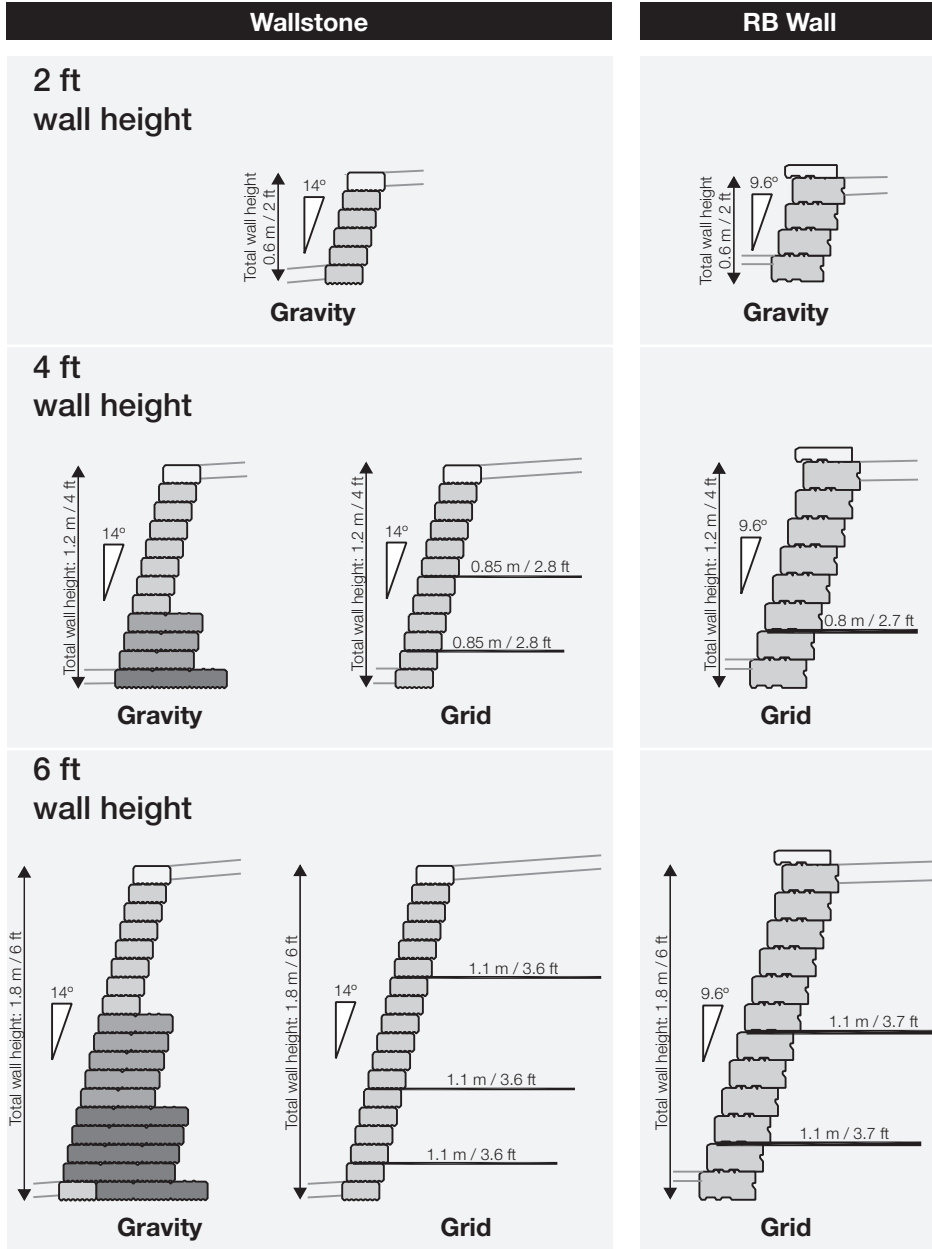

Notes: 1) Sample designs based on 2.4 kPa (50 psf) pedestrian surcharge. Use as preliminary design only when actual soil and surcharge conditions are conservatively represented by the standard engineering. In all cases, designs should be reviewed by a geotechnical engineer to ensure applicability to site. 2) Designs consider free draining sand and gravel backfill material compacted to 95% SPMDD to a minimum depth of 375 mm (15") behind the wall or to full extent of geogrid reinforcement, whichever is greater. Backfill materials to have less than 8% passing through the No. 200 sieve. 3) Designs consider 19 mm (0-3/4") well graded, crushed angular granular materials for a minimum depth of 200 mm (8") under the wall compacted to 98% SPMDD. Material to have less than 8% passing through the No. 200 sieve. 4) Designs consider minimum bearing capacity in subgrade soil below wall of 150 kPa (3000 psf).

Navascape retaining wall systems are ideal for shaped and multi-tier garden or structural walls, privacy walls, seating areas, stairs, columns and more. Special consideration is required for walls that exceed the maximum recommended height or are built in areas of poor drainage or soil conditions.

For unique circumstances not covered by our standard engineering, please contact our Design Services department.

Vertical Walls

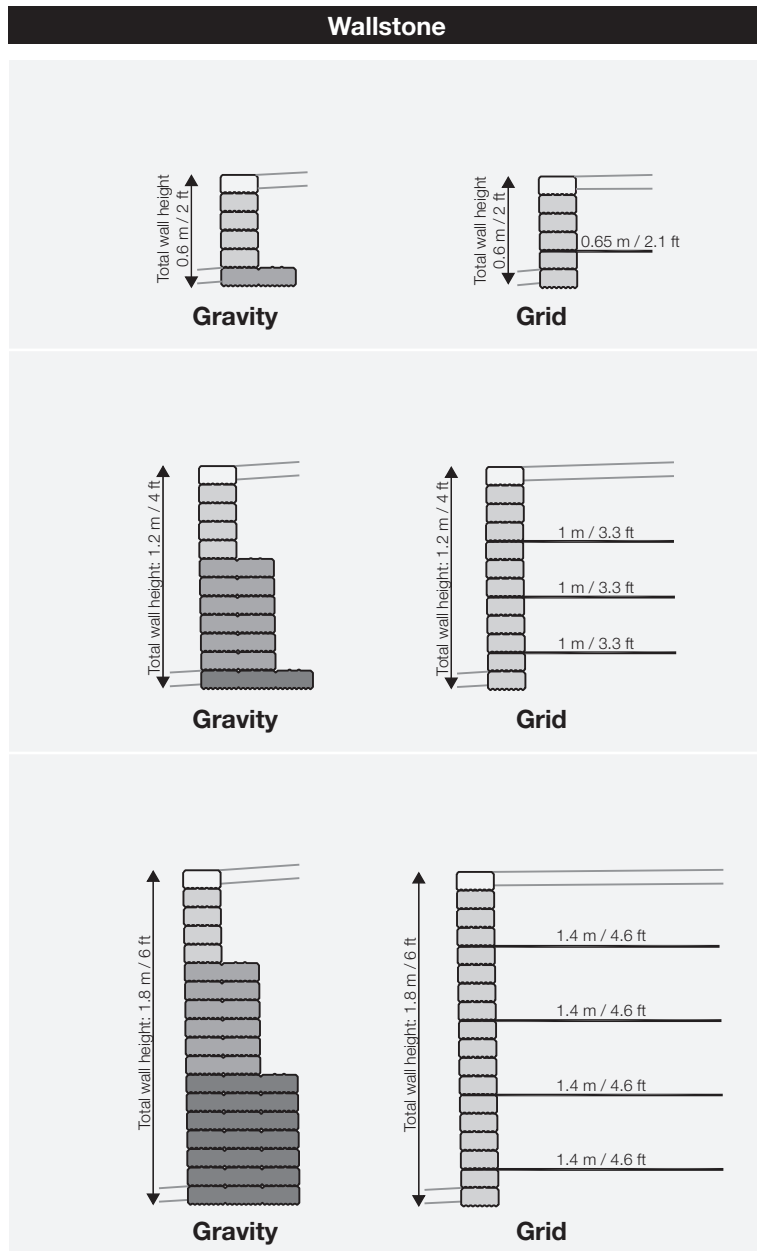

5) Different batter configurations, surcharge conditions or wall heights require different design configurations. 6) No provision has been made for overall global stability of the designs. 7) Minimum 100 mm (4") of product must be buried in all situations. Design may require more depending on soil conditions or toe slope. 8) Grid lengths are measured from front face of wall. 9) Geogrid used in designs is Miragrid 2XT or 3XT. 10) Designs for wall heights, batters and surcharges not represented on these pages can be attained from Navascape. 11) Refer to standard engineering drawings for further details. 12) Total wall height for RB Wall does not include coping unit. 13) Sample designs are not designed for handrail, guard or fence loading. In these cases, design modifications will be required. 14) Poor soil conditions and excessive moisture will require drainage and design modifications.

The following diagrams illustrate how to build steps, corners and columns using Navascape retaining wall systems. When building corners and columns, alternate between Row A and Row B each time you add a course to the wall. This creates a finger jointed corner for maximum strength and stability.

Visit us online at www.navascape.ca for additional information and standard engineering.

Wallstone

Corners

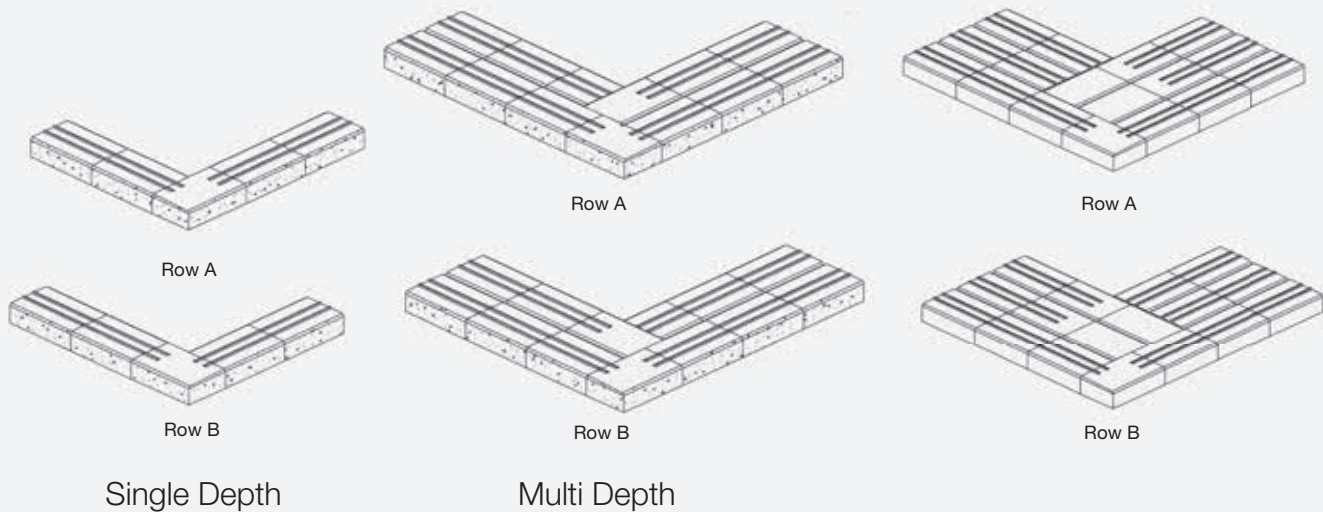

Steps

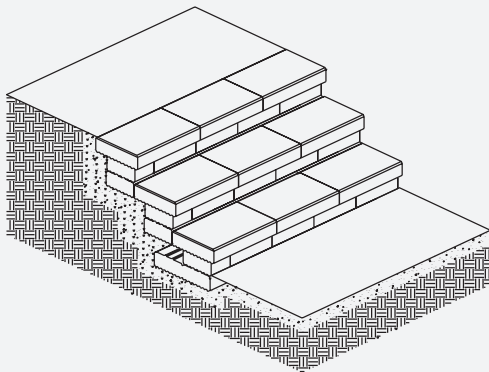

A Double Unit in the base of the bottom riser adds stability. Use 12" Coping units as the stair tread or, for a more comfortable step, Units.

To calculate product requirements:

Double Units = 1 x Step Width

Standard Units = [(2 x Step Width) x (# of Risers - 1)] + Step Width

Coping Units = (Step Width ÷ Coping Width) x # of risers

When building steps, the height of the riser can be adjusted by burying more or less of the second course of each riser. Tread depth is equal to the width of the coping unit used and can be increased by adding Navascape pavers behind the coping (see example below). Consider using bullnosed StoneTile or Bullnose Coping units as alternate coping options for your stair treads.

Visit us online at www.navascape.ca for product and standard step construction details.

RB Wall

Corners

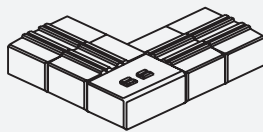

Row A

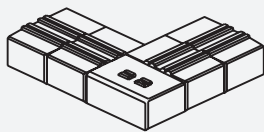

Row B

Single Depth

Steps

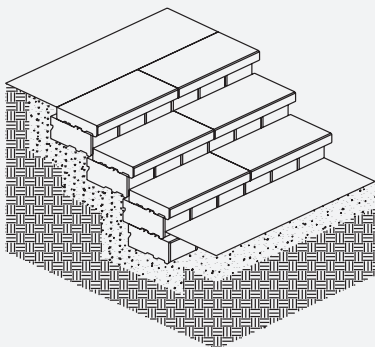

Risers are built using RB Standard units with 10" Coping or 24" Coping units as the tread.

To calculate product requirements:
 Standard Units = [(Step Width x 1.5) x # of risers] + (Step Width x 1.5)
 Coping Units = (Step Width ÷ Coping Width) x # of risers

Antique Hampton Wall

Columns

See illustration on page 30.

Steps

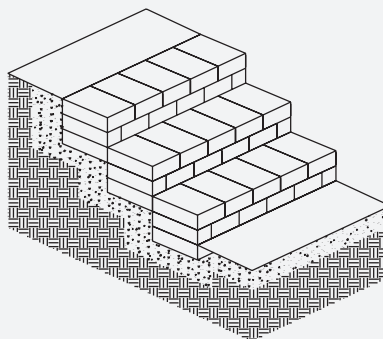

Steps are easily built using a single unit with Antique Hampton Wall. Joints must be staggered for step stability. Cutting of one piece per riser will be required.

To calculate product requirements:
 Standard Units = [(Step Width x 1.5) x 3] x # of risers

GRANDE Wall

Steps

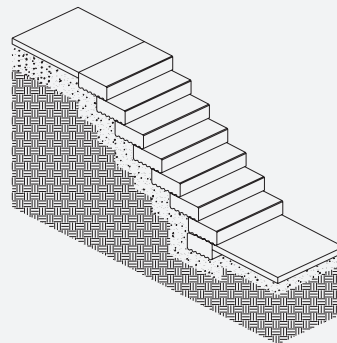

The GRANDE 438 Coping & Step unit is ideal for building stairs with a single unit. Step height is fixed but tread depth can be adjusted by moving the step above forward or backward or by incorporating Navascape pavers in each tread. Due to their size, GRANDE units must be mechanically placed.

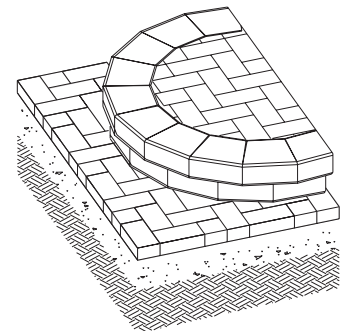

Half Circle Step

Half circle steps can be built using the Wedge or Taper unit from any Navascape retaining wall system by simply laying the blocks together in their natural curve. For additional stairs, alternate wedge blocks with half or full standard units to create a larger diameter. Fill the tread with Navascape pavers.

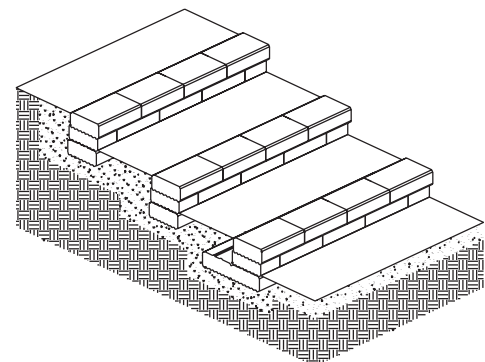

Adjustable Tread Depth

For a more gradual incline or a wider stair tread, Navascape pavers are used to adjust the run to the desired depth. Any Navascape retaining wall products can be used to create the risers.

Planning & Design

When planning a hardscape project, taking the time to do a little research and planning will ensure your project is successful. Consider the unlimited design potential of Navascape shapes, sizes, colors, patterns and textures. With so many possible combinations, the design possibilities are endless.

Design Ideas Collecting pictures and sketching your ideas on paper are your best planning tools. Whether you are considering doing the work yourself or hiring a professional, photos and sketches will help you to develop and communicate your ideas.

Evaluate Space Once you have a design in mind, measure out the space to help you visualize the area. This can be done with wooden stakes and a string line or by marking the ground with spray paint. If you are planning a patio, place some furniture or a BBQ in the area to help you evaluate the space. Measure distances to significant objects, such as buildings, trees, fences and steps as they can affect the layout of your project.

Select Product There are many products and designs to choose from with Navascape comprehensive selection of shapes, sizes, colors, patterns and textures. To help narrow down your selection, determine what is most important to you. Is it color, shape, laying pattern or texture? Once you have identified your priorities, browse through our catalogue or our website to find the products that suit your tastes.

Professional Contractors If you are planning a project that is more than 300 ft² (30 m²), it is recommended that you hire a professional hardscapes contractor. A contractor has the experience and equipment to complete your project faster and with professional results. Here are a few tips to consider when choosing a contractor:

- Visit the Interlocking Concrete Pavement Institute's website at www.ICPI.org to review their Consumer Guide brochure.
- Ask your local Navascape Dealer for contractor referrals.
- Meet in person with the contractor at your home to explain the project before obtaining proposals.
- Get written proposals from at least three contractors.

Required Tools Doing the job well and safely means having the proper tools. If you do not have these items readily available, they may be available for loan or rent from your local Navascape Dealer or tool rental store. In addition to the tools listed below, be sure to wear appropriate personal protective equipment (e.g. steel toed boots, gloves, eye protection) to prevent injury.

- | | | |
|--------------------------------------|--|----------------|
| ■ Hard toothed rake | ■ Pointed shovel | ■ Hammer |
| ■ Chalk or string line and stakes | ■ Chalk Marker | ■ Tape Measure |
| ■ 4' hand level or transit level | ■ 4" wide chisel (wall installations only) | ■ Wheelbarrow |
| ■ Vibrating compactor or hand tamper | ■ Push broom (paving installations only) | |
| ■ 1" screed rails (e.g. pipe) | ■ Paver cutter or masonry saw | |

Estimating & Ordering

Accurately measure and draft a plan of your project. An exact plan will enable you to accurately calculate the material quantities you will need to complete your project. In addition to the Navascape products you have chosen, you will need the following materials to ensure a quality installation. Use the calculation tables on page 47 for assistance in determining your material quantities or use our online estimator tool at www.navascape.ca.

Base Material: Proper base material is 25 mm (1 in) sized, crushed, angular, free-draining gravel material. The depth of base material required varies by application. Visit us online or consult your local Navascape dealer for more detailed base requirements.

- 100 - 200 mm (4 - 8 in) compacted base for patios, walkways and most retaining walls
- 200 - 300 mm (8 - 12 in) compacted base for driveways and parking areas.

Wall Backfill Material: Proper wall backfill material is a compactable, free-draining sand and gravel mix. For simplicity, the base material specified above can also be used for backfill. Pea stone, clear stone (No. 57), existing site soil and topsoil are not suitable backfill materials. The depth of the backfill material will vary, depending on the application of your wall. Consult your local Navascape Dealer for specific advice regarding your project.

Setting Bed Material (paving only): Use 2 mm (1 in) of clean, sharp sand (i.e. concrete sand).

Professional Accessories Navascape Dealers carry a complete line of professional accessory products needed to complete your project.

Landscape Adhesive (walls only): An adhesive should be used at corners and to glue the coping (top) course of the wall in place.

Edge Restraint (paving only): To prevent shifting, an edge restraint is recommended along all edges not abutting a building or wall.

Jointing Material (paving only): You will need approximately one bag of jointing material for the following:

- every 60 - 75 ft² (6 - 7 m²) of paving stones laid with narrow joints
- every 25 - 40 ft² (2.3 - 4 m²) of paving stones laid with wide joints
- every 100 - 125 ft² (9 - 12 m²) of architectural tiles or paver slabs.

When selecting a jointing material, remember that regular joint sand needs to be reapplied annually while more durable polymeric sand requires less maintenance. See the section on Jointing Material on page for assistance in choosing the right jointing material for your project.

Installation Guidelines - Paving

These installation guidelines apply to all Navascape interlocking paving stones, architectural tiles and paver slabs. There are some differences between installing paving stones and installing tiles or slabs, as noted in these guidelines. If your project includes both paving and walls, install the walls first.

Excavation & Base Preparation Determine the depth of the excavation by adding together the recommended depth of the base material and setting bed and the thickness of the product you have chosen. For paving stone installations and vehicular applications, the surface of the installed product should be 5 mm (0.25 in) above grade. During compaction, the product will settle into the setting bed, creating a strong interlock.

Be sure that your plan includes grading the area for proper drainage. A minimum grade of 1 cm per meter (1/8" per foot) is required to carry water away from house foundations and to prevent water from standing on the surface.

After excavation, spread the base material uniformly throughout the excavated area with a hard toothed rake in layers of no more than 100 mm (4 in). Use a tamper to compact the entire area evenly. Continue spreading and compacting base material until the desired depth is achieved and the surface has no high or low areas. Level the base to the desired grades, remembering to grade it so water is directed away from structures.

Constructing the Setting Bed A simple and accurate way to establish final grading and a good setting bed is to use a process known as screeding. Obtain screeding rails of approximately 25 mm (1 in) diameter or thickness (pipe is ideal). Set the screeding rails on the compacted base and use a transit or 4' hand level to check that the grades are accurate. Allow for a 20-25% rate of compaction for the uncompacted setting bed when setting rails. Carefully shovel the bedding sand around and between the rails. Run a screeding board, such as a straight 2x4 timber along the top of the rails to level the sand evenly. Reset the rails as needed to screed the entire project. Screed only the area you are able to cover with product that same day.

Installing the Edge Restraint Edge restraint prevents paving installations from shifting and spreading and is recommended on all edges of any installation not abutting a structure such as a building or a wall. The edge restraint must be installed on the compacted granular base material (not the setting bed). Although it can be installed after the product is laid, it is often placed first to serve as a starting edge.

Laying the Product Begin placing the stones on the setting bed in the desired pattern, starting at an edge or 90° corner. This will provide a straight line and reduce the need for cutting. Snap a chalk line or set a string line to follow when laying to ensure lines remain straight. Do not walk or kneel on the edges of tiles or near the edges of the paving installation as this may cause them to sink unevenly.

Some Navascape products are manufactured with spacer bars on the side to ensure accurate spacing of the joints. If the style you are using does not have spacer bars, leave a 1.5 - 3 mm (1/16 - 1/8") space around the product to act as a joint. In non-vehicular applications, architectural tiles and paver slabs can be laid butted tight together, without joints.

To ensure proper color distribution, take pieces from several bundles at a time. Remove paving stones in stacks rather than layers. Frequently look at the overall area and ensure good color distribution is being achieved throughout the project.

Cut the units as needed to finish edges. Do not install a cut piece that is less than 1/3 of its original size as pieces this small are likely to break. Instead, cut two larger pieces.

Walk around the project to ensure proper color distribution and that none of the units rock back and forth or are significantly lower than the others. Units are easily removed and replaced prior to compacting.

Compacting All interlocking paver installations must be compacted to ensure a strong interlock. Sweep the surface to remove any debris that could mar the surface of the product. Next, run the vibrating compactor up and down, then side to side over the entire installation. Any small irregularities in paver height caused during the laying process will be leveled out during compaction.

Compact the pavers at the end of each workday to within 1 m (3') of all unrestrained edges. The compactor should pass over all pavers a minimum of 2 times.

Paver slab installations and most architectural tile installations should not be compacted. Instead, tap the tiles with a rubber mallet after laying to settle them into the setting bed. However, architectural tiles used in a vehicular application [60 mm (2.36") modules only] must be compacted as above. In order to avoid marring the surface of the StoneTile modules during compaction, we recommend laying Mirafi 140 non-woven geotextile (available from your local landscape supply store) over the tiles prior to compaction.

Note: All paving slabs can be utilized in rooftop applications when set directly on roof systems.

Recommend min. 50mm thickness when elevated on pedestal systems.

Jointing Materials Jointing sands perform a critical role in the performance of interlocking systems by solidifying installations and are vital to ensuring effective interlock, particularly with paving stones. They maintain strength and integrity while also offering flexibility to expand and contract through all climactic conditions. In addition, proper maintenance of joints assists in the formation of an effective barrier that prevents weed or insect penetration within the joints.

There are a variety of jointing materials available:

- **Jointing Sand** - an inexpensive, manufactured, dry bagged sand that requires yearly maintenance to ensure optimum performance.
- **Polymeric Sand RG / Stabilizing Sand** - a polymer and sand based compound that is ideal to stabilize horizontal or sloping installations with joints of up to 13 mm (1/2"). Polymeric sand hardens once wet and requires little to no maintenance.
- **Polymeric Sand HP** - Similar to polymeric sand but in a high performance formula, this material is ideal for poolside paving, sloped installations, public areas with excessive traffic and any other paving installations with joints in excess of 25 mm (1").

Once all of the product has been installed and compacted (where necessary), install the preferred jointing material as follows:

Jointing Sand - Spread jointing sand liberally over the entire installation. Sweep jointing sand in all directions over the paving surface, making sure to fill in all the joints. Due to settling, repeat this process in successive days to ensure joints are packed and full of sand. Usually 2-3 applications are required. To speed up the settling process, vibrate the entire paving surface with a plate tamper or rubber mallet and then reapply sand, repeating this process until joints are full and firm.

Polymeric Sand / Stabilizing Sand - Sweep polymeric sand into the joints of the installation taking care not to sweep over long distances. Using a plate tamper or rubber mallet, vibrate the entire paving surface to compact the sand in the joints. Continue sweeping and compacting until joints are full and firm and the surface of the pavers is free of sand. In sections of 500 ft² (46 m²), moisten the sand lightly and continuously with a fine mist from a garden hose only until joints are moistened to their full depth. Do not flood or over water the surface. Let dry for at least 24 hours.

Mortar Bed Installation For information about installing our paving products using mortar and grout, refer to the Handbook for Ceramic Tile Installation, published by the Tile Council of America (www.tileusa.com). Your local building supply store can advise you about what type of mortar to use and how to install properly in this fashion.

Care & Maintenance of Paving Installations

Efflorescence Efflorescence is a chalky white residue that may appear on the surface of any concrete product. Salts that naturally occur in concrete are carried to the product's surface by water. When the water evaporates, the salts are left on the surface of the product as a white haze. The process will stop when no more salts are available to move to the surface. The length of time this takes can vary greatly, depending on granular materials used, climate and other factors. It is strongly recommended that you wait a minimum of 12 weeks after installation before sealing a project to ensure this process is complete. Sealing too early can trap efflorescence underneath the sealer, making it extremely difficult to clean.

Efflorescence does not affect the structural integrity of the product and is not considered a defect. With proper maintenance, efflorescence can be removed and the original color restored. The condition will usually correct itself with time and exposure to the elements or it can be removed quickly using an efflorescence cleaner.

Efflorescence cleaner is not recommended for use with NaturalCast architectural tiles and accent products due to their highly detailed surface textures. If it is absolutely necessary to use an efflorescence cleaner with these products, the following precautions should be taken:

- Add 50% more water than recommended by the cleaner manufacturer (e.g. if cleaner requires a standard 4:1 dilution, use a 6:1 dilution).
- Test on an extra stone or in an inconspicuous area first to ensure that the result is acceptable.
- Apply to small areas at a time to prevent the cleaner from drying on the stones.
- Rinse, rinse and rinse again. The area should be rinsed thoroughly for several hours. Volume of water is the key, not speed. Pressure washers are not recommended.

Cleaning & Sealing Using a sealer on a paving installation is a matter of personal preference. A sealer does not affect the overall durability or performance of the paver or tile but may enhance the color of the product and offer some protection against stains.

Before sealing an installation for the first time, any stains should be removed and the entire surface cleaned with an efflorescence cleaner. Use only cleaners and sealers specifically formulated for use on concrete pavers and follow the manufacturer's instructions. Always test the cleaning product on a small, inconspicuous area first.

Sealers can be either solvent or water based. Solvent based sealers are available in either a flat or a gloss finish. Water based sealers typically leave less gloss on the surface and are an environmentally friendly choice. Be sure the sealer you choose meets local environmental laws prior to use.

We recommend cleaning paved surfaces yearly to remove impurities and maintain the overall appearance of the paving stones. Spills should be treated immediately to prevent staining. For stubborn stains that just won't come clean, individual pavers can easily be removed and replaced with new ones. It is recommended that you reserve a small quantity of paving stones or tiles at the time of installation for this purpose.

Winter Maintenance Navascape products are regularly tested for durability resistance to de-icing salts, in accordance with current Canadian standard. However, excessive salting can result in the deterioration of any concrete product. We recommend using a salt/sand mixture on icy walkways and driveways. In the spring, the residual sand can be swept into the joints.

Not all nonsalt ice melter products are suitable for use with precast concrete. Consult the ice melter manufacturer for recommendations.

Typical Cross-sections - Paving

Interlocking Paver Patio / Walkway

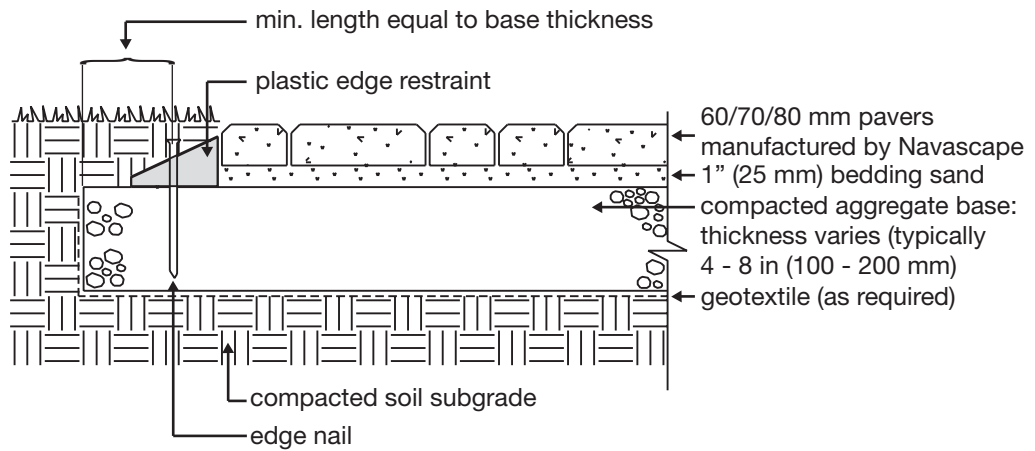

Interlocking Paver Driveway

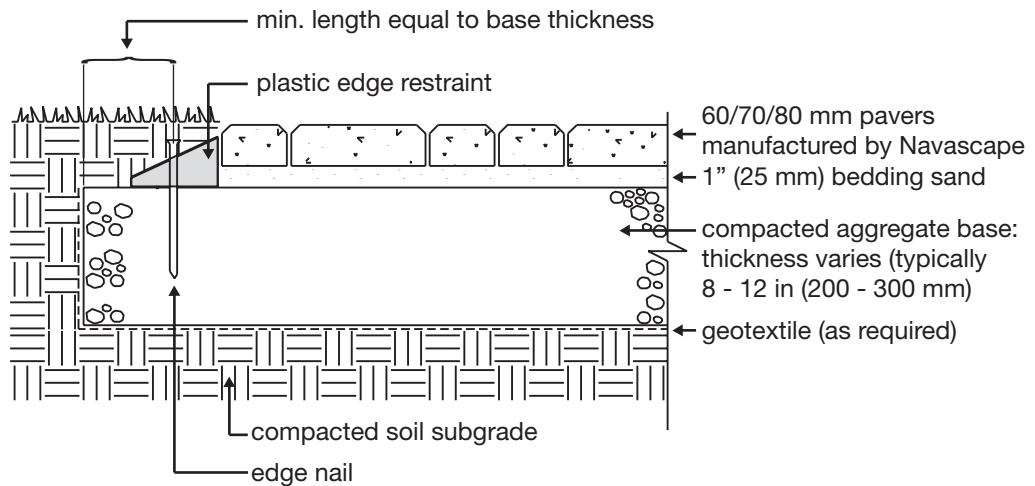

Architectural Tile Patio / Walkway

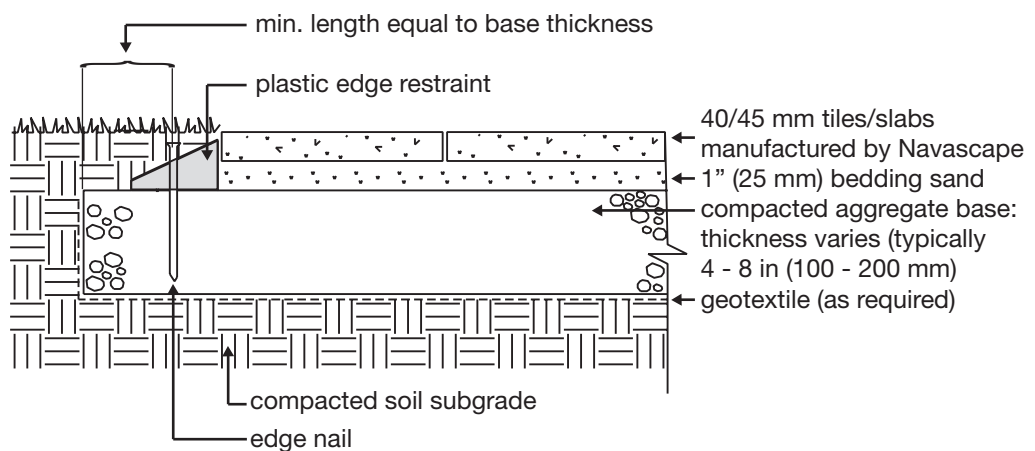

Installation Guidelines - Walls

These installation guidelines apply to garden and decorative walls built with any Navascape retaining wall system. For large structural or retaining walls, walls that exceed the maximum recommended height or walls in areas of poor drainage or soil conditions, please contact us for more specific installation requirements.

Design Considerations When planning a garden or retaining wall, you should ask yourself several questions to ensure your finished installation will look good and last a lifetime.

How high will the wall be? Height of the wall should always include a minimum of one buried base course in addition to the height above ground. Different wall systems have different height capabilities. Be sure not to exceed the maximum recommended height for the wall product you choose.

Will the wall be straight, curved or both? Navascape walls can create circles, soft flowing curves, straight linear designs or any of these in combination. Measure the curved and straight sections of the wall separately to make estimating easier.

What is the purpose of the wall? Some wall products are suitable for large retaining wall projects while others are ideal for small garden walls or planters.

Will the height of the wall vary? If the property has a slope, the wall height may vary accordingly. To make estimating easier, break the wall up into sections of equal height, always maintaining one buried base course.

Will the wall be terraced? If so, the front of the upper wall must be at least 1.5 times the height of the lower wall behind the back of the base course of the lower wall.

What setback do you need? Some Navascape wall products are capable of achieving vertical walls and other products have an automatic setback. Vertical walls typically can't go as high as setback walls without geogrid reinforcement. In addition, setback walls may require less product. When planning and measuring, keep in mind that a single setback moves the top of the wall back 25 mm (1") per course from the front of the base course.

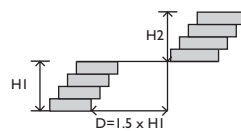

Terraced Walls

Walls that exceed the maximum recommended height, walls in areas of poor drainage and walls with extra loading at the top may require special engineering. Please contact Navascape for more information if your wall falls into one of these categories.

Excavation & Base Preparation Set an excavation line using a chalk or string line. To create an accurate radius, drive a stake into the ground at the desired center of your project. Attach a string to the stake equal in length to the desired inside radius. Rotate the string to indicate the location of the back of the first course. Once laid out, excavate a trench equal to the depth of gravel material plus the height of one unit, or to firm soil. The trench should be approximately 100 - 150 mm (4 - 6") wider than the wall block you have chosen.

After excavation, spread the base material uniformly throughout the trench with a hard toothed rake in layers of no more than 100 mm (4"). Use the vibrating or hand tamper to compact the entire area evenly. Continue spreading and compacting base material until the desired depth is achieved and the surface has no low or high areas.

Place screed rails at the desired grade of the underside of the first course of wall. Level the screed rails with a 4 foot level or transit level. Place granular base material between the rails and screed level with a straight edge, such as a 2x4 timber. Compact this area with a hand tamper. After compacting, place more granular base material between the rails and screed level. This is the level surface for laying the wall base pieces.

Base Course & Wall Construction Start placing the base course on top of the compacted base, beginning at the lowest point of the wall. Check alignment and leveling as you proceed. Continue with additional courses, adding and compacting backfill material behind the wall after every second course. To ensure adequate interlock between courses, we recommend a minimum joint overlap of 1/4 bond.

To ensure proper color distribution, take pieces from several bundles at a time, removing them in stacks rather than by layer. Tip: Check the levelness of the wall every 2-3 courses by putting a string line along the length of the wall. Shim or adjust the blocks as necessary to keep the wall lines straight.

Corner Construction Building corners with Navascape retaining walls is easy, whether they are curved, square or at any angle. Create curved corners using any of our wedge or taper blocks by simply laying the pieces in their natural curve. For gentler curves, gap the back of the pieces to fit the desired radius. Keep in mind that gaps in the wall layout will mean gaps in the coping (top) course unless coping units are cut to fit.

Building square corners is equally simple with Navascape retaining walls (see corner construction details on page 38). We strongly recommend building a finger jointed corner as it is the strongest corner that can be built. In addition, it is recommended that you use a landscape adhesive between all courses at the corner for increased strength.

Coping Installation The coping course adds the finishing touch to your wall project. Because of the tongue and groove features of many Navascape walls, the coping course offers multiple placement options - set it forward or in line with the rest of the wall, or use a wider coping piece and center it over the rest of the wall. Whatever placement option you choose, the coping pieces are simply set on top of the rest of the wall.

An adhesive should be applied in two continuous beads along the outer edge of each top rib of the course below the coping. This will secure the coping to the rest of the wall.

Step Construction Steps can be built using any Navascape wall products (see page 38 for detailed step construction drawings). The base underneath and behind a step remains the same as the base underneath and behind a wall. Tread width can be customized by installing Navascape pavers. When including steps as part of a larger wall, build the main wall and the returns first, then construct the steps.

Using Wall Systems in Combination Many of our wall systems include both straight and wedge or tapered blocks that can be used alone or in combination for maximum flexibility. The RB, Wallstone and GRANDE systems can easily accommodate straight, curved or combination walls.

There are a few tricks that can assist you with combining standard and wedge or tapered units in the same wall:

- You may have to gap blocks at the back of the wall every second course to make the blocks sit properly. A gap of 75 mm (3") is acceptable for Wedgestone Wall and 130 mm (5") is acceptable for GRANDE Wedge.
- The second course may not have exactly the same configuration as the course below it. Once again, gapping the blocks may be necessary. In a vertical wall, the first course will match the third course, the second course will match the fourth course and so on.
- You may need to remove or modify some of the ribs on the bottom of the block to make the next course sit flat. Removal of ribs is acceptable but should be kept to a minimum, as this is the primary connection mode between courses.

Typical Cross-section - Walls

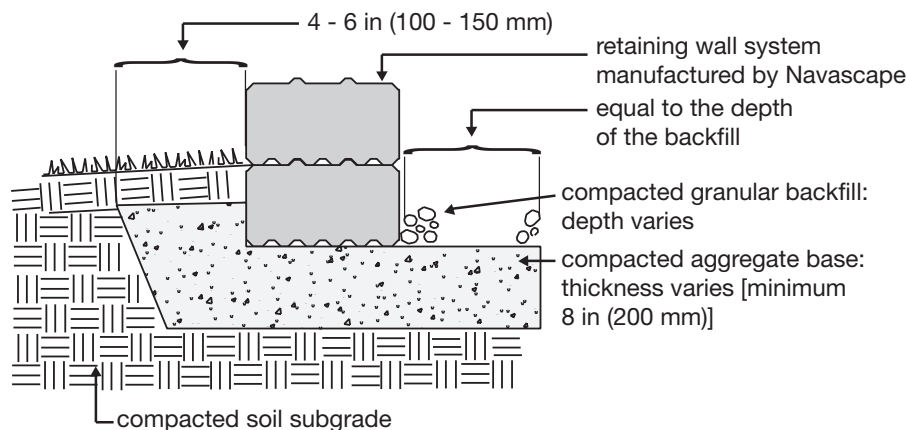

The charts below will assist you in calculating the material requirements for your project. Quantities given include approximately 5% overage for cutting. For additional assistance, use our online estimating tool at www.navascape.ca.

Typical Project Material Requirements

Material	3 x 20 ft (0.9 x 6.1 m) Walkway	12 x 12 ft (3.7 x 3.7 m) Patio	20 x 30 ft (6.1 x 9.1 m) Driveway
Navascape pavers, architectural tiles or paver slabs	63 ft ²	150 ft ²	630 ft ²
Granular base material	1 yd ³	3 yd ³	23 yd ³
Setting bed material	0.2 yd ³	0.5 yd ³	2 yd ³
Edge restraint	40 ft (2 edges)	48 ft (4 edges)	60 ft (2 edges)
Jointing material	1 bag	3 bags	10 bags

Your Project Material Calculator

Material			Your Project		Total Required
Navascape pavers, architectural tiles or paver slabs	1.05	x	ft ²	=	ft ²
Granular base material (walkway/patio - 4" deep)	0.0123	x	ft ²	=	yd ³
Granular base material (walkway/patio - 6" deep)	0.0185	x	ft ²	=	yd ³
Granular base material (driveway - 12" deep)	0.037	x	ft ²	=	yd ³
Setting bed material (1" deep)	0.0031	x	ft ²	=	yd ³
Edge restraint (along any edges not abutting a wall, building or other permanent structure)	1	x	ft (perimeter)	=	ft
Jointing material (pavers - narrow joints)	0.0167	x	ft ²	=	bags
Jointing material (pavers - wide joints)	0.04	x	ft ²	=	bags
Jointing material (architectural tiles / paver slabs)	0.01	x	ft ²	=	bags

Base Depth Chart (yd³)

	1"	2"	3"	4"	5"	6"	7"	8"	9"	10"	11"	12"
100 ft ²	0.3	0.6	0.9	1.2	1.5	1.9	2.2	2.5	2.8	3.1	3.4	3.7
200 ft ²	0.6	1.2	1.9	2.5	3.1	3.7	4.3	4.9	5.6	6.2	6.8	7.4
300 ft ²	0.9	1.9	2.8	3.7	4.6	5.6	6.5	7.4	8.3	9.2	10.2	11.1
400 ft ²	1.2	2.5	3.7	4.9	6.2	7.4	8.6	9.9	11.1	12.3	13.6	14.8
500 ft ²	1.5	3.1	4.7	6.2	7.7	9.3	10.8	12.4	13.9	15.4	17.0	18.5
600 ft ²	1.8	3.7	5.6	7.4	9.2	11.1	13.0	14.8	16.7	18.5	20.3	22.2

Metric Conversion Chart

When you know:	Multiply by:	To find:
Inches (in)	25.4	Millimeters (mm)
Inches (in)	2.54	Centimeters (cm)
Feet (ft)	30.48	Centimeters (cm)
Feet (ft)	0.3048	Meters (m)
Square Feet (ft ²)	0.0929	Square Meters (m ²)
Cubic Feet (ft ³)	0.037	Cubic Yards (yd ³)

Helpful Formulas

Soldier Course

$$\frac{\text{Length of soldier course (in)}}{\text{Width of paver (in)}} = \text{\# of pcs required}$$

$$\frac{\text{\# of pcs required}}{\text{Pcs/ft}^2} = \text{\# of ft}^2 \text{ required}$$

Area

Circle = πr^2
= 3.14 x radius x radius

Rectangle = length x width

Triangle = 1/2 base x height

Perimeter

Circle = πd
= 3.14 x diameter

Rectangle = 2 x (length + width)



Sales & Service - Canada

Cambridge, ON Mississauga, ON
800 265 6496 800 562 8490

Ontario

R. R. #2, 1081 Rife Road 201 Universal Road
Cambridge, ON N1R 5S3 Woodstock, ON N4S 7W3
519 740 6000 519 421 2131
800 265 6496

7447 Bren Road
Mississauga, ON L4T 1H3
905 672 1388
800 562 8490

Lifetime Warranty

Navascape Hardscapes products are backed by a lifetime warranty to the original purchaser of the products for residential applications. This assurance of product quality is applicable where products have been correctly installed to meet the manufacturer's specifications. Color variances and the appearance of efflorescence do not constitute a warranty claim.

Any defective products will be replaced; however, replacement labor and transportation costs are not included in this warranty.

All warranty claims must be made prior to the removal or disposal of the defective product; approvals must be in writing. This warranty is not transferable. Proof of purchase is required.

